

RADIO-CRAFT

HUGO GERNSBACK, Editor

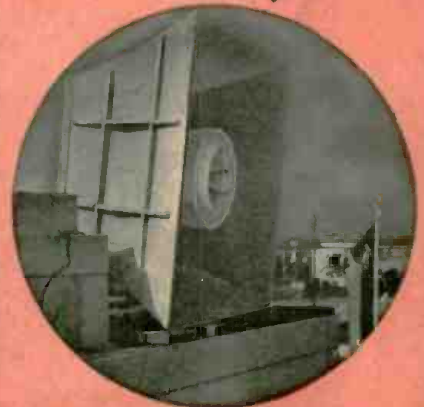

SOUND!--
Vital Factor
at World's Fairs
See Page 272



COAXIAL SPEAKER

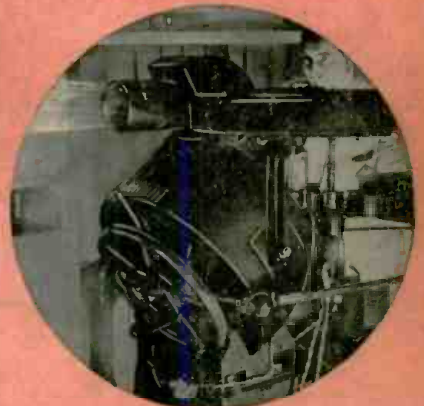

FLICKERLESS TELE-FILM



RUBINOFF'S P.A. VIOLIN

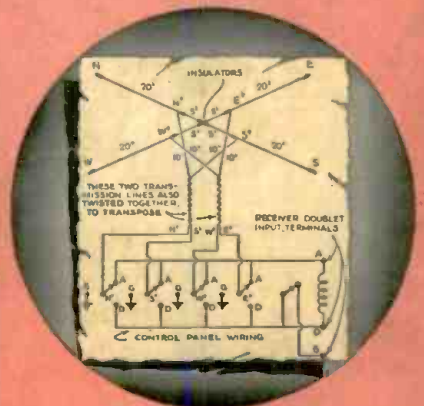

NEW DX ANTENNA

NOV. RADIO'S GREATEST MAGAZINE
25c
FREE ADVICE ON P.A. PROBLEMS! • DX DIRECTIONAL AERIAL
NEW TEST EQUIPMENT • 9-INCH IMAGE ON 5-INCH TELLY KIT
U.S. AND CANADA

Now...

5 VITAL FEATURES

COMBINED AND UNIFIED IN THE

AMPERITE VELOCITY

WITH ACOUSTIC COMPENSATOR

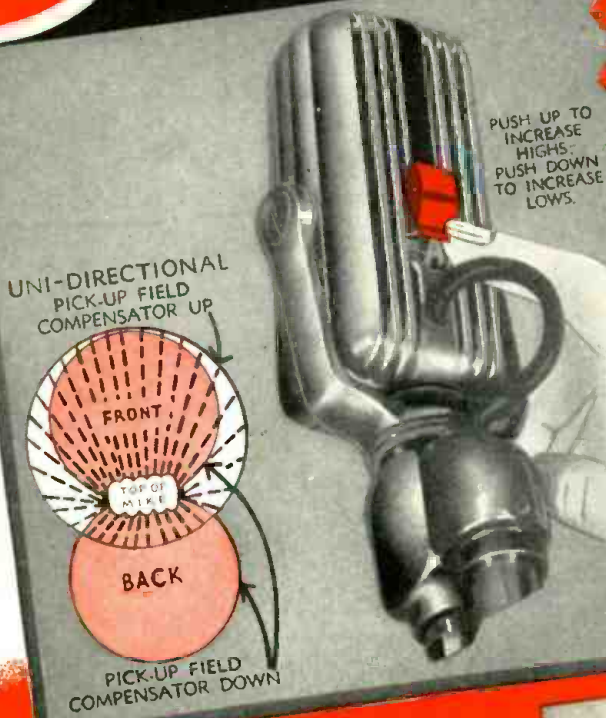

- it's a VELOCITY
- it's a DYNAMIC
- it's UNI-DIRECTIONAL
- it's NON-DIRECTIONAL
- gives HIGH OR LOW PITCH

By moving up the Acoustic Compensator, you change the Amperite Velocity Microphone to dynamic operation—without pecks. At the same time you reduce the back pickup, making the microphone practically uni-directional. With the Acoustic Compensator down, the microphone is bi-directional... 120 degrees front and back without frequency discrimination. Rotating the microphone until it parallels the ceiling makes the microphone non-directional.

THE ACOUSTIC COMPENSATOR is a regular feature of these models: RBHk (hi-imp); RBMk (200 ohms) LIST \$42.00. RSHk (hi-imp); RBSk (200 ohms), \$32.00 LIST



FOR TOP-NOTCH QUALITY, AND AMAZING RUGGEDNESS, AT LOW COST specify Model RAH (or RAL).

Here's why this popular Amperite Velocity Microphone leads the low-price field: (1) it is excellent for both speech and music; (2) has flat response without undesirable peaks; (3) reduces feedback; (4) stands up under rain, wind, heat, and rough handling. . . . Frequency range 60 to 7500 CPS. Output, -68 db. **MODEL RAH** (hi-imp), with 12' of cable; **MODEL RAL** (200 ohms), with 8' of cable. . . . \$22.00 LIST.



SELL "CONTACT MIKES" to Professional and Amateur Musicians. New high output model can be used in the home.

Professional musicians are buying Amperite "Contact Strad." Now amateurs, too, can benefit by the "Contact Mike." The new **HIGH OUTPUT MODEL SKH** can be used in the home. It operates on most radio sets made since 1935. It is connected to the phono-input, or to grid ground of detector tube, or across the volume control. Note new clamp, making the mike easy to attach to guitars, ukes, etc. **MODEL SKH** (hi-imp); **SKL** (200 ohms) \$12.00 LIST. Any number up to 5 SKH's can be put in parallel and fed into one input. **NEW FOOT PEDAL**, \$12.00 LIST. **CLAMP** for Contact Mike, \$1.00 LIST.



Sales Aids for the P. A. Man

- (1) FREE Window Decal advertising your Sound Service. Size 5 1/4 x 9 1/4, finished in 4 colors.
- (2) FREE Window Display, 11 x 17.
- (3) Special Sound Equipment Letterheads. Samples and prices on request.
- (4) FREE use of cut for printing business cards, etc.

AMPERITE Co. 561 BROADWAY, N. Y., U. S. A. CABLE ADDRESS ALKEM, NEW YORK

"Better Systems Specify Amperite"

VELOCITY AMPERITE MICROPHONES

A FREE LESSON SHOWED BILL HOW HE COULD MAKE GOOD PAY IN RADIO

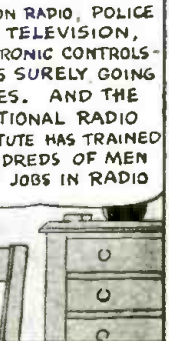
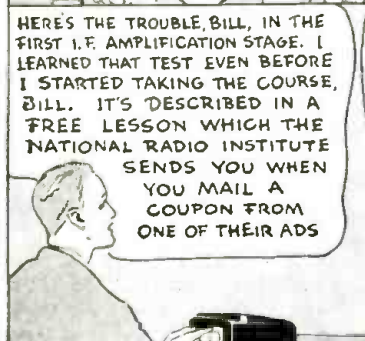
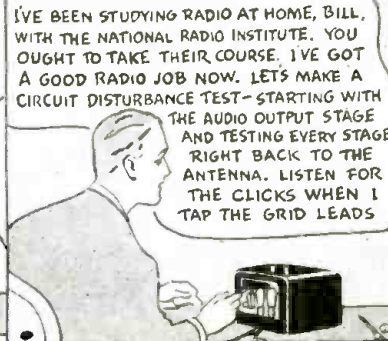

I will send you a Lesson on Radio Servicing Tips FREE
 TO SHOW HOW PRACTICAL IT IS TO TRAIN AT HOME FOR
GOOD JOBS IN RADIO



Clip the coupon and mail it. I'm so certain I can train you at home in your spare time to be a Radio Technician that I will send you my first lesson free. Examine it, read it, see how clear and easy it is to understand. See how my course is planned to help you get a good job in Radio, a young, growing field with a future. You don't need to give up your present job, or spend a lot of money to become a Radio Technician. I train you at home in your spare time.

I send special Radio equipment; show you how to conduct experiments, build circuits. This 50-50 training method makes learning at home interesting, fascinating, practical. I devote more than 10 Lesson Texts exclusively to Television, and discuss Television fundamentals thoroughly in my Course.

J. E. SMITH, President
 National Radio Institute
 Established 25 years
 He has directed the training of more men for the Radio Industry than any one else.



Jobs Like These Go to Men Who Know Radio
 Radio broadcasting stations employ engineers, operators, technicians and pay well for trained men. Radio manufacturers employ testers, inspectors, foremen, servicemen in good-pay jobs with opportunities for advancement. Radio jobbers and dealers employ installation and servicemen. Many Radio Technicians open their own Radio sales and repair businesses and make \$30, \$40, \$50 a week. Others hold their regular jobs and make \$5 to \$10 a week fixing Radios in spare time. Automobile, police, aviation, commercial Radio; loudspeaker systems, electronic devices, are newer fields offering good opportunities to qualified men. And my course includes Television, which promises to open many good jobs soon.



I Also Give You This Professional Servicing Instrument

Here is the type of instrument Radio Technicians use--an All-Wave Set Servicing Instrument. It contains everything necessary to measure A.C. and D.C. voltages and currents; to check resistances; adjust and align any set, old or new. It satisfies your needs for professional servicing after you graduate--can help you make extra money fixing sets while learning.

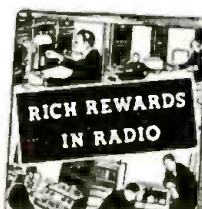

J. E. SMITH, President
 Dept. 9MX, National Radio Institute, Washington, D. C.



Many Make \$5 to \$10 a Week Extra in Spare Time While Learning
 The day you enroll, in addition to my regular course, I start sending you Extra Money Job Sheets which start showing you how to do actual Radio repair jobs. Throughout your course I send plans and directions which have helped many make \$200 to \$500 a year in spare time while learning.

Get Sample Lesson and 64-page Book Free--Mail Coupon

Act today. Mail coupon now for Sample Lesson and 64-page Book. They're FREE. They point out Radio's spare time and full-time opportunities and those coming in Television; tell about my course in Radio and Television; show many letters from men I trained, telling what they are doing and earning. Read my money back agreement. Find out what Radio offers you. Mail coupon in envelope or make an penny postcard--NOW!

J. E. SMITH, President
 Dept. 9MX, National Radio Institute
 Washington, D. C.

Dear Mr. Smith: Send me FREE, without obligation, your Sample Lesson and 64-page book "Rich Rewards in Radio" which tells about Radio's spare time and full-time opportunities and explains your 50-50 method of training men at home to be Radio Technicians. (Write Plainly.)

Name Age

Address

City State

Please Say That You Saw It in RADIO-CRAFT

RADIO-CRAFT

HUGO GERNSBACK, *Editor-in-Chief*

N. H. LESSEM
Associate Editor

THOS. D. PENTZ
Art Director

ROBERT EICHBERG
Trade Digest Editor

R. D. WASHBURNE, *Managing Editor*

Contents NOVEMBER, 1939 Issue

VOLUME XI -- NUMBER 5

Editorial: War Radio.....	Hugo Gernsback	261
The Radio Month in Review.....		262
Converting a 5-inch Telly Kit for Receiving a 9-inch Image—Part I	Charles Sicuranza	264
Announcement: Mr. Serviceman, Public Address Man and Sound Specialist—FREE Consultation and Design Service!.....		266
3rd Group of Prize Winners— <i>Radio-Craft's</i> P.A. Contest.....		267
How to Add 1 to 14 Modern Features to the All-Push-Pull Direct- Coupled 30-Watt Amplifier—Part II.....	A. C. Shaney	268
2-Way Telly Demonstration.....		270
How to Build a "Junkbox" Electric Guitar	Frank E. Chambers, W9BMN	271
Sound—Vital Factor at Both World's Fairs.....		272
Review of the F.C.C. Allocations of Ultra-Shortwaves.....		274
Mailbag		275
A Combination DX Directional Receiving Aerial.....	Charles R. Leutz	276
An Easily-Built Stage Analysis Tester.....	James F. Rinke	278
"Fade-Ometer"—A New Instrument for Servicemen....	Paul R. Dunlap	280
Condensers—Minus Guesswork.....	William Robinson	281
New Circuits in Modern Radio Receivers—No. 26....	F. L. Sprayberry	282
Servicing Questions & Answers.....		283
Operating Notes		283
Hints on "Portable Sound".....		283
Useful Kinks and Circuits.....		284
Making Milliammeter Multipliers.....	E. H. Thompson	284
Servicing "Coin-Operated" Phonographs—No. 6 (Service Diagram)	Sanford Miller	285
RADIO SERVICE DATA SHEETS:		
No. 264—Sonora Model TW-49.....		286
No. 265—Stewart-Warner Model 03-5A1 to 03-5A9 (Chassis 03-5A) Senior Varsity.....		287
Radio and Interphone.....	Dennis DeVoe	288
Radio Trade Digest.....		289
The Latest Radio Equipment.....		294
Book Reviews		259 and 299

SPECIAL FEATURES in the NEXT ISSUE

Newest Equipment for Serv-
icemen

Higher-Fidelity Loudspeaker
for Frequency-Modulated-
Station Programs

Newest 9-Tube Hi-Fi Set
Introduces "Harmonic
Converter"

Installing an Electronic Or-
chestra

★

Television is here to stay! Already in the larger cities regularly scheduled telecasts are on the air. Commercial receivers however are still too high-priced for most of the people to enjoy this latest form of entertainment. In an effort to bring television sets within the reach of the general pocketbook *Radio-Craft* presents on pg. 264 an article which shows how to convert a comparatively inexpensive 5-in. television kit to one using a 9-in. cathode-ray tube.

The total cost for the kit and parts necessary for its conversion will run considerably below the least expensive commercial 9-in. television receiving set! If you are interested in television, here is your opportunity not only to brush up on the principles of television by actually constructing your own unit but also to have and enjoy the benefits of a modern, 441-line television receiver.

★

Published by Radcraft Publications, Inc. Publication office: 29 Worthington Street, Springfield, Mass. Editorial and Advertising Offices: 99 Hudson Street, New York City. Chicago Advertising Office: RADIO-CRAFT, 520 North Michigan Avenue, Chicago, Ill.

RADIO-CRAFT is published monthly, on the first of the month preceding that of date; subscription price is \$2.50 per year in U. S. and Canada. (In foreign countries, \$3.00 a year to cover additional postage.) Entered at the post office at Springfield as second-class matter under the act of March 3, 1879.

Foreign Agents:

London—Gorrings's American News Agency, 9A Green St., Leicester Square, W. C. 2, England.

Paris—Messageries Dawson, 4 Rue Faubourg, Poissonniere, France.

Melbourne—McGill's Agency, 179 Elizabeth St., Australia.

Dunedin—James Johnston, Ltd., New Zealand.

★

Text and illustrations of this magazine are copyright and must not be reproduced without permission of the copyright owners.

★

Copyright 1939 Radcraft Publications, Inc.

BOOK REVIEWS

ENGINEERING OPPORTUNITIES, by R. W. Clyne (1939). Published by D. Appleton-Century Company. Size 6 x 8½, cloth cover, illustrated, 397 pgs. Price, \$3.00.

Here is an interesting and extremely helpful guidebook for those who wish to enter or learn more about engineering. More than 25 engineering opportunities are described by representatives of leading American companies. Each chapter is written by a representative of a foremost American company engaged in the particular field described. The section on radio is written by Richard N. Chindblom of C.B.S. The topic is condensed to 9 non-technical pages. Other topics include physics, aviation, diesel power, glass, metallurgy, photography, plastics, etc.

RADIO LABORATORY HANDBOOK, by M. G. Scroggie (1938). Published by Iliffe & Sons, Ltd., London, England. Size, 5 x 7½ ins., cloth covers. 384 pages, 211 illustrations. Price, \$2.50 (approx.).

"Radio Laboratory Handbook" has been specially compiled for amateurs, both beginners and advanced workers, and for industrial and official laboratory engineers. It gives the serious radio worker complete information from first-hand experience about laboratory equipment, the instruments which are necessary, and the correct methods of operating them.

The fundamental principles are fully discussed. Other sections deal with ultra-high frequency work, the working out of results, and reference data. There is also a collection of the most useful symbols, abbreviations, formulas, laws, curves, tables and other data.

The information contained covers all that is necessary for advanced work, but a high degree of prior knowledge is not assumed. The book is, therefore, particularly valuable to laboratory engineers, students and teachers in technical colleges and schools running experimental radio classes, and to radio societies.

THE RADIO MANUAL (3rd Edition—Completely Revised), by George E. Sterling (1938). Published by D. Van Nostrand Company, Inc. Size 6 x 8 ins., cloth, flexible cover, 1,120 pgs., 443 illustrations. Price, \$6.00

In every kind of radio work—for every type of equipment—this book furnishes the most up-to-date, expert and complete information. It gives every fact needed to learn the fundamentals, to obtain licenses, to pass examinations for government and commercial positions, and to apply the newest methods, instruments, and regulations. For every practical radio problem it furnishes the experience of an outstanding authority, who has obtained the cooperation of several well-known specialists, and drawn freely upon many sources of data that are not commonly available.

Its 20 chapters start with Elementary Electricity and Magnetism and conclude with Aeronautical Radio and Teletype Procedure, and appendices that discuss rules, regulations and special instructions regarding aeronautical and marine radio. Transmitters, receivers, direction finders, automatic alarms, and police transmitters and receivers are described; together with the latest F.C.C. rules, and the regulations decided upon at the Cairo Conference.

HANDBOOK OF AMATEUR TUBE USES, edited by Engineering Staff, Raytheon Production Corp. (1st Edition). Published by Raytheon Production Corp. Size 8½ x 11 ins., paper covers, 72 pages, generously illustrated. Price, 50c.

Here is an invaluable contribution to the library of the radio amateur; practically all of the design ideas were originated by amateurs, including developments by the technical staff of the A.R.R.L.

Partial table of contents (incomplete listing here): Choosing a Tube; Tube Manufacture and Construction, and Classification by Structure and Function; Typical Speech Amplifier and Class B Modulators; Grid Driving Power and the Exciter; Output Impedance and L/C Ratio; Modulation; Detector Performance; Ultra-Highfrequency Operation; Plate Colors of Raytheon Amateur Tubes at Rated Dissipations; Conversion Curves; Resistance-Coupled Amplifier Design Curves; Receiving Tubes; Miniature Lamps; Tubes for Special Applications.

RADIOTECHNIQUE — Les Principes Acoustiques et Electriques et Leurs Applications (Electrical and Acoustical Principles and Their

Applications), by R. Springer (1939). Published by Dunod, Paris, France. Size 6½ x 10 ins., paper cover, 405 pgs., 241 illustrations. Price, \$2.50, paper, and \$3.05, bound; add 12% for shipping costs.

This book, written entirely in French, was prepared by R. Springer in collaboration with a group of outstanding engineers, including Manfred von Ardenne, Hanns Gunther, Eugene Nesper, Rolf Wigand, and others. Here is a book that goes into great detail to analyze the operation of radio and public-address circuits and equipment; a small amount of mathematical treatment is included. The book is highly recommended to anyone who wants to learn modern radio technique from the ground up and who is conversant with technical French.

HISTORY OF RADIO—to 1926, by Gleason L. Archer (1938). Published by The American Historical Society, Inc. Size 6½ x 9½ ins., cloth cover, 421 pgs., illustrated. Price, \$1.00.

Unlike most books on history, Archer's "History of Radio" offers reader interest—combined with historical accuracy. Valuable material never before printed, taken from personal and departmental files, is made public for the first time. This volume is the outgrowth of the course on radio broadcasting in the College of Journalism of Suffolk University. A general-interest, semi-technical book.

We mention here only a few of its chapters: 1—Intercommunication of Signals in Early Times; 13—Pioneer Days in Radio Broadcasting; 20—Wavelengths and Injunctions.

RADIO DICTIONARY, by Leonard Lewis. Published by The Dahls. Size 4 x 6¼ ins., paper cover, 44 pgs. Price, 50c.

Radio and broadcasting terms dictionary. The only book of its kind written by a radio executive. Lists hundreds of terms and signals. Complete with list of stations, call letters, etc. Handy for radio executives, salesmen, writers, advertising agencies and librarians.

LOOK AND LISTEN, by M. B. Sleeper (1939). Published by The Norman W. Henley Publishing Company. Size 6½ x 9 ins., over 100 illustrations, 96 pgs. Durable spiral flexible binding. \$1.00; cloth binding, \$1.50. The book lies flat when opened.

It is frequently possible to get an insight into the comparative value of a new book by noting its author. We therefore point out that "Look and Listen" is written by a television engineer and Member, I.R.E., who is also the author of numerous radio books; founder and editor of *Radio Engineering* magazine, Mr. Sleeper has been actively identified with the radio industry since 1916.

This television handbook supplies concrete facts about the status of the television art as of April 30, 1939—the inaugural date of 441-line telecasting on a schedule basis.

This unindexed book is subdivided as follows (chapter headings briefed by reviewer): Introduction—Television: A newly-created field of unlimited opportunity for radio Students, Set-Builders, Experimenters and Servicemen; Chapter I—The uncharted field of television development . . . ; Chapter II—The Modern Television Transmitter; Chapter III—Functions of a Modern Teleceiver; Chapter IV—Assembling the Andrea model KT-E-5 Teleceiver; Chapter V—The Television Antenna; Chapter VI—Installation of Teleceivers; Chapter VII—Service Notes and Trouble-Shooting Charts for Andrea models 1-F-5 and KT-E-5 Teleceivers; Chapter VIII—Dictionary of Television Terms.

Charts of special interest to telly Servicemen are titled "Chart Indicating Tube Failures" and "Sight and Sound Chart." Included in the book, loose, are 3 picture diagrams and a schematic circuit of the Andrea models 1-F-5 and KT-E-5 teleceivers.

"Matching Loudspeakers"

This article was announced last month as being scheduled to appear in November *Radio-Craft*. However, last minute changes necessitated rescheduling this article for a forthcoming issue. Meanwhile, don't forget to write to us regarding the special announcement on page 266.

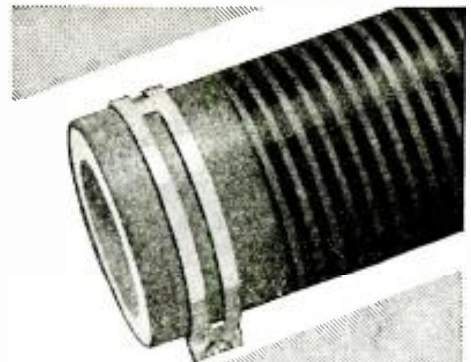

MILLION VOLT RESISTORS...

Maybe you don't need million volt resistors . . . yet it is worth knowing that the same famous IRC Metallized resistance principle, best known in the little ½, 1- and 2-watt Insulated Resistors for radio use, has now made possible outstanding advances in both high voltage and ultra high frequency resistors for advanced scientific research purposes.

10,000 ohms at ½ watt—100,000 volts at 150 watts—1,000 megohms at 150 volts . . . regardless of the need, the IRC Metallized element can supply them all, dependably and economically.

"Metallized" Resistors are made under IRC patents in eight countries. The Metallized type of element is the most adaptable yet produced. No other resistance material holds such an outstanding record of past success. None holds such broad possibilities for future development. Whatever your need—insist on the best!



"They Stay Put"



INSULATED

Metallized

RESISTORS

TYPE BT

INTERNATIONAL RESISTANCE CO

401 N. Broad St., Phila., Pa.

Please Say That You Saw It in RADIO-CRAFT

It's NEW—and it's the one and only
P. A. HANDBOOK



**ONLY
 25
 CENTS
 A COPY**

**MOST COMPLETE
 AND AUTHENTIC
 P. A. BOOK PUBLISHED**

THAT no book has yet been published which covers amplifiers and sound systems (also kindred systems), in one complete, authentic volume is almost unbelievable. Yet, it is a fact, there is no book in print which covers Public Address from A to Z. To bridge this wide-spread gap, RADIO-CRAFT will publish, on October 15th, a volume on Public Address of such magnitude—so complete and authoritative—that every man engaged in radio can have both a theoretical and practical knowledge of the function and operation of sound systems. The editorial pages are so filled with instruction and replete with illustrations that the volume fully justifies its title—1939-40 AMPLIFIER HANDBOOK AND PUBLIC ADDRESS GUIDE. This great HANDBOOK on Public Address should be read and studied by those who consistently build, service and sell sound equipment.

A MATCHLESS VOLUME

As complete as you would expect to find any engineering handbook—this is how the radio or P. A. man finds the **AMPLIFIER HANDBOOK AND PUBLIC ADDRESS GUIDE**. With essential technical data compiled from an exceptionally large number of sources, the volume covers nearly two hundred different subjects coordinating every conceivable branch or sub-division of Public Address.

THE CONTENTS

To actually show the scope and magnitude of the **AMPLIFIER HANDBOOK AND PUBLIC ADDRESS GUIDE**, an analysis of the contents is found at the right, showing the breakdown of the material featured within each particular section. A thorough reading of the contents shows the completeness of this book.

**A Resume of the Contents of the
 AMPLIFIER HANDBOOK
 AND PUBLIC ADDRESS GUIDE**

PREFACE

INTRODUCTION

CHAPTER I—FUNDAMENTALS

Vacuum Tube as Amplifier—Ratings—Bels and Decibels—Harmonics—Distortion—Attenuation—Gain—Ohm's Law—Bridge Circuits—Rectification—Microphones—Condensers—Resistors—Impedance—Phase—Resonance—Inductance—Frequency—Magnetism—Shielding.

CHAPTER II—VACUUM TUBES

Voltage Amplifiers—Power Amplifiers—Control and Indicator Tubes—Rectifiers—Ballast and Regulator.

CHAPTER III—CIRCUIT ANALYSIS

Inputs—Coupling—Degeneration (Inverse Feedback)—Frequency Compensation—Outputs—Push-Pull—Phase Inversion—Class A, A-B, B, A₁, etc.—Hum-Bucking—Automatic Gain Control—Spectrum Control—Time-Delay—Tone Compensation—Voltage Dividers—Swinging Chokes—Beam Power—Push-Pull.

CHAPTER IV—MICROPHONES

Carbon—Condenser—Electrodynamo—Ribbon (Velocity)—Crystal—Lapel—Uni-directional (cardioid)—Electromagnetic—Transducers.

CHAPTER V—AMPLIFIERS AND PREAMPLIFIERS

A.C.—D.C.—A.C.-D.C. (120 V.)—A.C.-D.C. (6 V. D.C.—120 V. A.C.)—Mobile—Portable—Multi-Channel—Biphonic—Preamplifiers—Monitors.

CHAPTER VI—LOUDSPEAKERS

Magnetic—Dynaonic—P.M. Dynamic—Crystal—Horn Units.

CHAPTER VII—HORNS AND BAFFLES

Flat—Infinite—Octave Resonance—Exponential—Flares—Labyrinths—Peridynamic—Biphonic.

CHAPTER VIII—AMPLIFIER COMPONENTS

Resistors—Condensers—Transformers—Chokes—Fuses—Sockets—Chassis and Housings—Meters—Name Plates and Bezels—Terminals—Jacks and Plugs—Switches—Frequency Filters—Bias Cells—Tone and Volume (Attenuator) Controls—Pads—L. T. H., etc.

CHAPTER IX—POWER SUPPLIES

Power Lines—Batteries—Converters and Generators—Rectifier Tubes—Dry Rectifiers—Vibrators and Inverters—Bias Supplies—Field Exciters—Ballasts and Regulators.

CHAPTER X—ACCESSORIES

Coin Phonographs—P. A. Tuners.

CHAPTER XI—RECORDING AND PLAYBACK

Pickups—33-1/3 and 78 r.p.m. Turntables—Film, Disc and Wire—Recorders—Lateral and Vertical (hill-and-dale) Recording—High Fidelity Recording and Playback—Accessories.

CHAPTER XII—MATCHING AND MIXING

Input to Amplifier—Amplifier to Line—Line to Speakers—Pads—Attenuators—Matching Amplifiers—Booster Amplifiers.

CHAPTER XIII—ACOUSTICS

Absorption—Reverberation and Echo—Low-Level Distribution—High-Level Distribution.

CHAPTER XIV—SELLING SOUND

Ethics—Who are the prospects?—What are reasonable charges?—Sloganes—Accounting—Advertising and Publicity.

CHAPTER XV—SCHOOL SOUND SYSTEMS

CHAPTER XVI—CALL SYSTEMS

Railroads—Hotels—Restaurants.

CHAPTER XVII—INTERCOMMUNICATORS

Wire Type—Wired-Radio Type—Switchless—Multiple-Station.

CHAPTER XVIII—TALKIES

Soundheads—Amplifiers—Loudspeakers—Sound-on-Film—Sound-on-Disc—Home-Talkies—Commercial-Talkies.

CHAPTER XIX—HEARING AIDS

Tubeless—Tube Type.

CHAPTER XX—MISCELLANEOUS APPLICATIONS

CHAPTER XXI—FORMULAS AND TABLES

CHAPTER XXII—TEST EQUIPMENT

Multi-Meters—C.-R. Oscilloscope—A.F. Oscillators—Output (Level) Indicators—V.T. Voltmeters.

CHAPTER XXIII—INSTALLATION PROCEDURE

Placement of Equipment (Microphones, Amplifiers, Loudspeakers)—Use of Woofers and Tweeters—Wiring—Indoors and Outdoors—Portable and Mobile Set-Ups—Permanent Installations.

CHAPTER XXIV—SERVICING

RADCRAFT PUBLICATIONS ■ 99 HUDSON STREET ■ NEW YORK, N. Y.

RADCRAFT PUBLICATIONS, INC. ★ 99 HUDSON STREET ★ NEW YORK, N. Y. RC-1139
 Gentlemen: Enclosed find my remittance of 25c for which send me POSTPAID, one copy of your NEW—1939-40 AMPLIFIER HANDBOOK AND PUBLIC ADDRESS GUIDE.

Send me others, for friends, also POSTPAID @ 25c each.

Name Address

City State

Remit by check or money order; register letter if you send cash or unused U.S. Postage Stamps.

Order Your Copy NOW—

*Clip Coupon and
 Mail Today!*

Please Say That You Saw It in RADIO-CRAFT

RADIO-CRAFT

“RADIO'S GREATEST MAGAZINE”

WAR RADIO

By the Editor — HUGO GERNSBACH

THE first World War, from 1914 to 1918, found Radio as yet in its infancy. Looking back to those days it should be noted that modern radio, as we know it today, still had not appeared on the scene. Radio broadcasting, that is, transmitting the human voice through space, was not known. This came much later; namely about 1921. We still used spark and CW transmission; that is, code by the dot and dash method. Crystal detectors, electrolytic detectors and magnetic detectors, were still modern in those days. The vacuum tube, in the last few years of the war, with its highly inefficient construction, had just arrived on the scene. Many of the old-timers will remember the famous VT-1 and VT-2 tubes of the World-War days. These were the triodes, or three-element tubes and of course were battery-operated. The efficiency of our radio sets in those days was still poor and vacuum tubes were not to be trusted too much; and on account of the heavy battery equipment required, such a thing as a portable vacuum-tube radio receiver was hardly ever considered then.

During the past 20 years all of this has been changed and modern radio has become of tremendous importance, not only to the warring nations, but to neutrals as well.

Broadcasting, to begin with, is used more and more as a common weapon for propaganda because it is easy to transmit intelligence across international borders and such broadcasts are often difficult to stop by the enemy. Elaborate broadcast means are therefore used on each side of the warring camps to drown out any suspicious war propaganda that might find its way to the listeners of the other country. Immediately that such a broadcast is heard, the affected country promptly goes on the air on the same wavelength either with phonograph records or with other radio-mechanical noise producers; the noise sometimes being of the “buzz-saw” variety. This shrieking, irregular note or noise-broadcast often effectively drowns out the enemy’s propaganda.

Yet, despite all this, some broadcasts get by and take effect. But, inasmuch as both sides are doing it, people usually take such enemy emissions with a grain of salt, and it is often most difficult for the population to differentiate between what is true and what is pure fabrication. In Nazi Germany, for instance, where censorship is extremely strict and where particulars of the true conditions existing in other countries are never read in the German press, it is doubtful that such French or English propaganda—as is not obliterated—will influence the German mind very greatly.

The most astonishing thing, at least during the early stages of the war, has been the European broadcasts received in the United States direct from London, Paris, Berlin and Warsaw. American representatives of our national networks have talked to us almost daily from the respective warring capitals and often American listeners have wondered why these countries allowed such broadcasts to go on the air at all. The answer, of course, is again simply the word “propaganda.” More important yet, is the point often overlooked, that these broadcasts are usually very tame and contain little information that the war bulletins given out by the warring countries have not contained. So, all we hear in these international broadcasts is a news rehash, plus a little local color; but of actual war conditions, of course, we hear nothing because the broadcasters are warned that no important information can ever be divulged in this manner.

A curious fact, overlooked even by radio people, is that the radio transmitting aeriels are excellent guides for bombers and enemy airplanes. As many of our radio readers know, when in the United States an aviator is forced to fly blind in a storm or fog, often the only way that he can get his bearings is by listening to a broadcast station by means of his radio direction finder. He can then orientate himself and fly directly in the direction of the transmitter. Of course, he knows where that transmitter is located. His map tells him that. It is naturally the same in Europe, and for that reason during a black-out when enemy airplanes approach, broadcast stations are usually shut down so as not to give the enemy raider his bearings. The chances are that this condition will become more intensified as time goes on.

So far, the greatest radio havoc of the war has been that created among radio amateurs. As each country declares war, the first thing that the governments do is to curtail amateur transmission and for that reason it is not possible today for American amateurs to receive messages from amateurs of any of the warring countries. This will even hold true with Canada, which declared war as we go to press, and it is a foregone conclusion that Canadian amateurs too, will be shut down until the end of the war. This is regrettable, because it was found during the first World War that amateurs made the backbone of the radio signaling system and it is therefore felt that the amateurs, deprived of their radio work, will not be in good practice if they have to stop transmitting for one or more years. To be sure, radio amateurs in whatever warring country they are, will probably be drafted anyway, except for the younger ones who have not reached military age.

The reason for closing down on amateurs during the war is obvious. Spies and other unauthorized persons could use amateur radio channels to communicate with the enemy; particularly submarines, etc., and for that reason it is difficult to find a good reason why amateur radio should not be suspended during the war, much as this is regretted.

As to the technical side of war radio, it is impossible in a short article of this type to describe the really tremendous rôle that radio really plays. There is hardly any part of the warring personnel these days that is not radio-equipped. Tanks, scouting airplanes, bombers, submarines, artillery, anti-aircraft gunners, all are radio-equipped and know the value of instant communication with headquarters. Such a thing as the American Lost Battalion in the Belleau Wood in the first World War probably would not happen again today. Even the marching infantry is radio-equipped these days. Not only that, but every part of the mechanized army from the caisson to mobile guns all have radio equipment. Machine-gunners at outposts have their 2-way radio, so that if necessary, they can be immediately directed either to advance or retreat, as conditions may indicate. No longer is it necessary to wait for runners or field-telegraph. Radio takes care of the modern army in ALL of its movements.

It should also be remembered that modern radio is so efficient that it is possible to send intelligence only for extremely short distances, even as little as 10 yards without the signal passing beyond such a distance; the signals also may be made quite directive. This flexibility of radio becomes very important, particularly for war-time uses, and for this reason it will be used a great deal during the present war.

THE RADIO MONTH



RUBINOFF'S P.A. "STRAD"

Here shown practicing, Dave Rubinoff later played to an audience of 5,000 persons at the Mississippi Valley Music Festival, last month. The Stradivarius (insured for \$100,000) was supplemented by an Amperite "Kontak" mike and an RCA sound system. Edward H. Gordon, sound engineer, is at right.

WAR CLOUDS

AMATEUR radio in Canada went into hibernation last month when the Canadian Government said "No, no a thousand times no," or words to that effect, with regard to the continuation of ham radio transmission and reception, as one of the long tentacles of the European war octopus reached toward Uncle Sam's next door neighbor.

European powers last month ordered that the transmitters aboard their ships not be operated. The idea of course was, and is, to reduce, thereby, the possibility of revealing to an enemy power the position of a ship which would thus be disclosed if its signals were picked up

by a receiver equipped with a direction-finding (loop) aerial.

The mailed fist of the God of War last month opened, and when it closed it enfolded England, France, Germany and Poland in a rigid censorship of every form of communication—radio, telegraphy and telephony.

TELEVISION

WIRE-TELLY 6,000 miles? We don't know for sure, but it seems from a letter sent to *Radio-Craft* last month in reply to inquiries by this department, that John Bull has stolen a march on every other country in supplying new "picture" equipment to Russia. The report states that Standard Telephones and Cables, Ltd., of London, last month shipped to Russia specially-designed transmission apparatus which will make possible the operation of several telephone and telegraph circuits, simultaneously, by "carrier" (substantially, wired radio). Included in the equipment is "a channel for broadcasting or picture transmission"; it is not clear whether this use of the word "picture" is a reference to a facsimile picture (permanent record) or a television image (transient view). Crossing Siberia, the open wire lines will join Moscow and Khabarovsk, 6,000 miles apart.

Last month the F.C.C. included in its Radio Service Bulletin the following additions to the growing list of telly stations:

- W2XBT—N.B.C. portable, 92 mc.
- W3XP —Philco, 204 to 210 mc.
- W3XAD—RCA, 321 to 327 mc.

Television opens to the totally deaf a whole new world, observed Mrs. Eve-

lyn Sass, national lip-reading champion in 1930, during a visit last month to G.E.'s exhibit at the New York World's Fair 1939. Mrs. Sass was able to read the lips of announcers and performers. Too, television would make it possible for the totally deaf to "telephone."

The construction permit requested last month by Bamberger Broadcasting Service, Inc., at 1450 Broadway, N.Y.C., is for a new telly station on 84 to 90 mc., and with a power output of 1 kw.

NEW CALL LETTERS

COLUMBIA'S international shortwave station W3XAU henceforth will be announced as WCAI, in conformity with new rules and regulations of the F.C.C.

Reason for the change to new call letters lies in the fact that the experimental status of shortwave broadcasting has been removed by the F.C.C., International Shortwave now being designated as a regular service. The "X" in the former call letters (W3XAU) was a symbol of experimental service.

Westinghouse station W1XK, Boston, has joined the ranks of the International Shortwave stations which have received calls minus the "X", and now is known as WBOS.

General Electric stations W2XAF and W2XAD, both in Schenectady, have become, respectively, International Shortwave stations WGEO and WGEA. The Treasure Island station at the San Francisco World's Fair, formerly W6XBE, has now become KGEI.

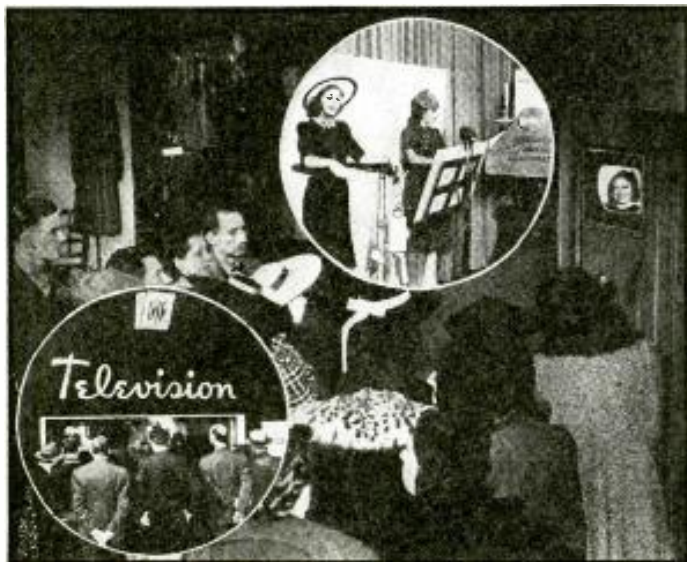

TELEVISION MAKES SELLING EASIER

Wire-television may soon find extensive application in department stores and other large places where a central television studio may be conveniently connected by cable to a number of remote teleceivers. For example, Bloomingdale's, large department store in New York City, last month introduced American Television Corp.'s Tele-Sales System, with a well-balanced program of live and film subjects. Studio programs were fed to 8 remote Kinets (teleceivers). Photo at left shows (top-inset) aligning frame which centers subject on movable platform; onlookers (bottom-inset) outside studio; and, onlookers at a remote Kinet. This department attended a press demonstration of Bloomingdale's Tele-Sales System set-up and forecasts a great future for this use of wire-television.

IN REVIEW

FREQUENCY MODULATION

EXTENSIVE tests of frequency modulation are being planned by several large groups. The Bell Telephone Labs. plans, announced last month, call for comparative tests of frequency- vs. amplitude-modulated communication between aircraft and automobiles. Test stations will use 20 watts on 38.6 mc. for each of 4 portable-mobile stations, viz.: W10XJT, -U, -V, and -W.

The National Broadcasting Co. last month received permission to go on the air with 1,000 watts, on 42.6 mc., over a frequency-modulated station atop the Empire State Building.

The Yankee Network, Inc., last month received the "go ahead" signal to operate station W1XOK as a relay station for high-fidelity programs from a frequency-modulated station in Boston, Mass. The relay station is to use 50 watts, on 133.03, 134.85, and 136.81 mc.

The Westinghouse Elec. & Mfg. Co.'s station W8XKA, Springfield, Mass., will shortly be on the air with a 1 kw. frequency-modulated transmitter on 42.6 mc.

FACSIMILE

ASPECIAL facsimile edition of *The Dallas Morning News* will be published as soon as the new RCA equipment is installed in station W5XD, the ultra-H.F. station which is associated with WFAA. The facsy programs will go out on 25.25 mc., with a power of 1,000 watts.

Other newspaper-owned stations in the U.S. now transmitting facsy material with similar RCA equipment are:

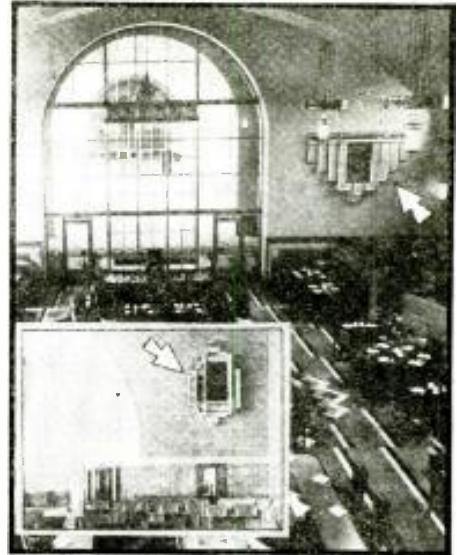

UNION TERMINAL'S NEW SOUND INSTALLATION

Union Passenger Terminal at Los Angeles, which cost \$11,000,000, would not have been complete without its huge sound system which provides public address facilities, recorded music and radio programs for waiting passengers. Sound seeks out the passengers no matter whether they're in the ultra-modern restaurant (photo at right shows one of the decorative loudspeakers), or in the waiting room (inset photo shows the type of speakers used here). Photo at left shows part of the special control room.

WBNS, Columbus, Ohio; KSD, St. Louis, Mo.; WBEN, Buffalo, N. Y.; KMJ, Fresno, Calif.; and KFBK, Sacramento, Calif.

The 3-day Army war games scheduled last month to take place at Plattsburg, N. Y., were to be recorded by station WMCA. After being used as the basis of a broadcast the discs were to be turned over to the U. S. Army for use in military instruction and as a permanent record of the maneuvers. Recorders mounted in special cars, for ranging over the 25-mile front, were to operate from special studios.

President Roosevelt, during his 10 days on board the U.S.S. *Tuscaloosa*, each morning when he arose was handed a Finch facsimile record of material sent out the previous night, it was reported last month.

These programs were received from WOR, which transmits via the RCA system Tuesdays, Wednesdays, and Thursdays, and with the Finch system on the remaining two days.

SOUND

"SO SORRY we are giving you lots of trouble," Japs announced, last month, over a P.A. system erected before their sentry posts and aimed at British defenders of the foreign settlement in Tsientsin, China.

According to reports, last month, the N.B.C. telly transmitter atop the Empire State Building interfered with the orchestra sound-system of the Hotel McAlpin a couple blocks away. It seems that the hotel amplifier detected and amplified the sound portion of the telly program which thus mixed with the P.A. program, both being heard at the same time by the hotel guests.

Here's a good talking point for the Serviceman who wants to sell sound to his local church: "If it's good enough for the Cathedral of St. John the Divine and St. Patrick's Cathedral in N. Y. C., it must be good enough for any church."

(Continued on page 300)

...ing their way leisurely through minded children in Warsaw and the
look like little puffs of cotton. ... was struck and demolished
Sixty
down 4
lost, it
same thi
ing was
battles
The
At 4
watcher
planes
three He
from a li
day's fo
low the
over the
Shrap
the Ger
Polish r
again an
kels as
cloud bu
This
(Co

Nazis Are Warned to Shun Foreign Radio

Berlin, Sept. 1 (U.P.).—Effective tonight, anybody in Germany who listens to a foreign radio broadcast is subject to a prison term, while those who spread reports from such broadcasts are liable, in special cases, to the death penalty.

"Every word coming from a foreign radio station is a lie," an official announcement declared.

The war measure, designed to preclude the dissemination of foreign propaganda and information adverse to the interests of Germany, said at the outset:

"Modern war and military weapons are only the means toward a decision. The influencing of the morale of the people is most important."

(N. Y. Daily News)

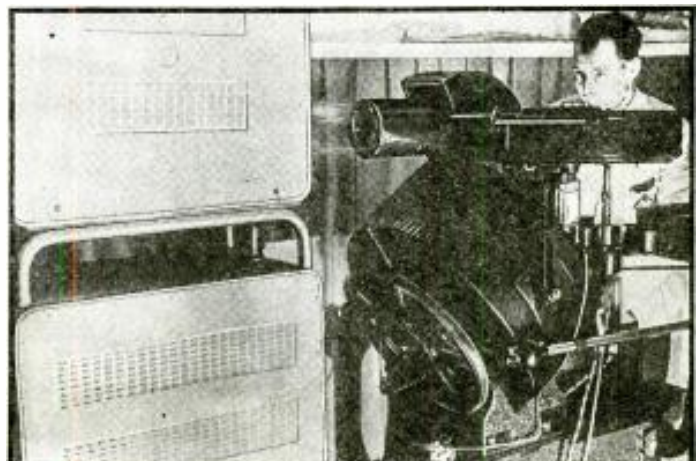

FLICKERLESS TELE-FILM

Radio-Craft last month received the above photo which shows Telefunken's new 441-line television film-projector. It is equipped with a projection-wheel which is lined with mirrors, thus permitting film-projection without flicker-effect. (Additional information is given at the end of this department.)

RADIO LISTENING VERBOTEN
The 1-station models of the People's receiver are now the only radio sets permitted to be used in Germany, and woe betide the unlucky experimenter who gets caught making any changes which permit a second, and possibly foreign, station to be heard. All the multi-band receivers have been confiscated.

Converting a 5-inch Telly Kit FOR RECEIVING A 9-INCH IMAGE

Here's a plan for building a "5-inch" television receiver from a standard kit, becoming familiar with its operation, and then making the necessary changes so that this basic kit may operate a 9- or 12-inch Kinescope. Viewing is thereby greatly improved. It's probably the least expensive way so far suggested for obtaining a virtual 9- or 12-inch teleceiver.

OF THE several commercial television kits available to experimenters and Servicemen, the writer chose the Meissner 5-inch receiver kit because it was admirably suited to his plan.

It was felt that the plan of converting this telly kit to use a larger cathode-ray tube would be of interest to the hundreds of Servicemen who have already built the kit and also might be of interest to those who prefer a larger image to begin with.

Let it be said at the outset that the writer could find no

CHARLES SICURANZA PART I

fault with the 5-inch kit—either with the operation or with the image size—except that one time 14 people squeezed into a small workroom to see a program

and although everyone saw and liked the image, it was rather trying to have 6 or 8 people draped around one's neck for a solid hour, hence the conversion idea took shape.

Further, the plan has great educational value as well as considerable economic value. However in fairness to both the reader and the manufacturer it should be stressed that the kit be built first as a standard 5-inch job to learn how to work it properly and then it can be converted in easy stages as will be shown in Part II.

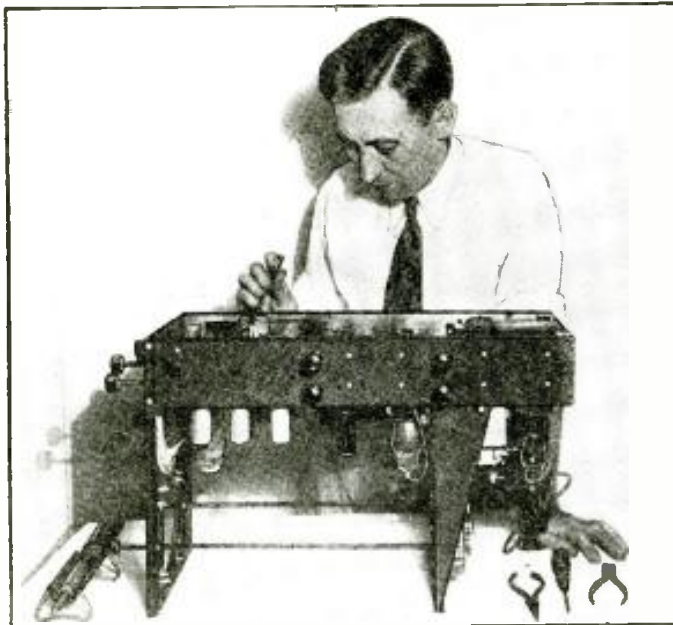

Handsome "Charlie" Sicuranza, author, going through the final alignment process on the 5-in. telly receiver. The cathode-ray tube is not yet in place.

"DO'S AND DON'T'S"

The remainder of this Part I will be devoted to a review of some "do's and don't's" in building the set and a discussion of the necessary changes that will be made later on. If you are wondering what you are going to do with the 5-inch cathode-ray tube after converting the set, well—you need a good television 'scope anyway, so why not build one later on and make good use of that tube.

The first "don't" is, not to handle the 1852 (or 1853) like an ordinary tube. Don't "thump" the tube; and *never* drop it on the bench or floor. These tubes because of their close spacing, develop grid-to-cathode shorts very easily when dropped. Result—loads of plate current, and then burnout. Don't try to hurry the wiring job; "make haste slowly" as the manufacturers say, as they really mean it.

Even the assembly job is no cinch, so we will pass on a few hints to prospective builders. Mount the octal sockets first—each socket has a tube number on it. Be sure each socket keyway faces in the proper direction as shown in the pictorial diagram supplied with the kit; and don't forget to put a terminal lug on the 2—6F8G socket screws and also on the 6V6G socket. Scrape the chassis bright at one corner of each socket plate and put a spot of solder on each one. Do this now because later it will be hard to do properly with the wiring in place. The next step is to mount every terminal lug

strip shown on the diagram. Look particularly for misplaced grounding straps on these lugs. Each one should look exactly like those shown in the diagram.

Mount *under* the chassis the 4 metal plates which hold the electrolytic condensers. Mount *over* the chassis the 3 bakelite plates for the remaining electrolytics. Mount the flat, wire-wound resistors and safety switch. Check these resistors for opens and grounds before mounting. Assemble all parts on the safety wall and mount permanently on to the main chassis.

Mount the front panel on the chassis and leave the speaker and hand-change switch off to the very last. Mount all the I.F. transformers in their proper places according to number. Leave the low-voltage and high-voltage power transformers off until the last of the wiring is in.

The bracket which holds the single-plate variable condenser should be well soldered to the chassis; likewise the

(Continued on page 304)



A close-up view of the 5-in. telly receiver with rear safety cover removed. The 2 upper controls on the side skirt are for image size and the lower 2 are for vertical and horizontal speed control.

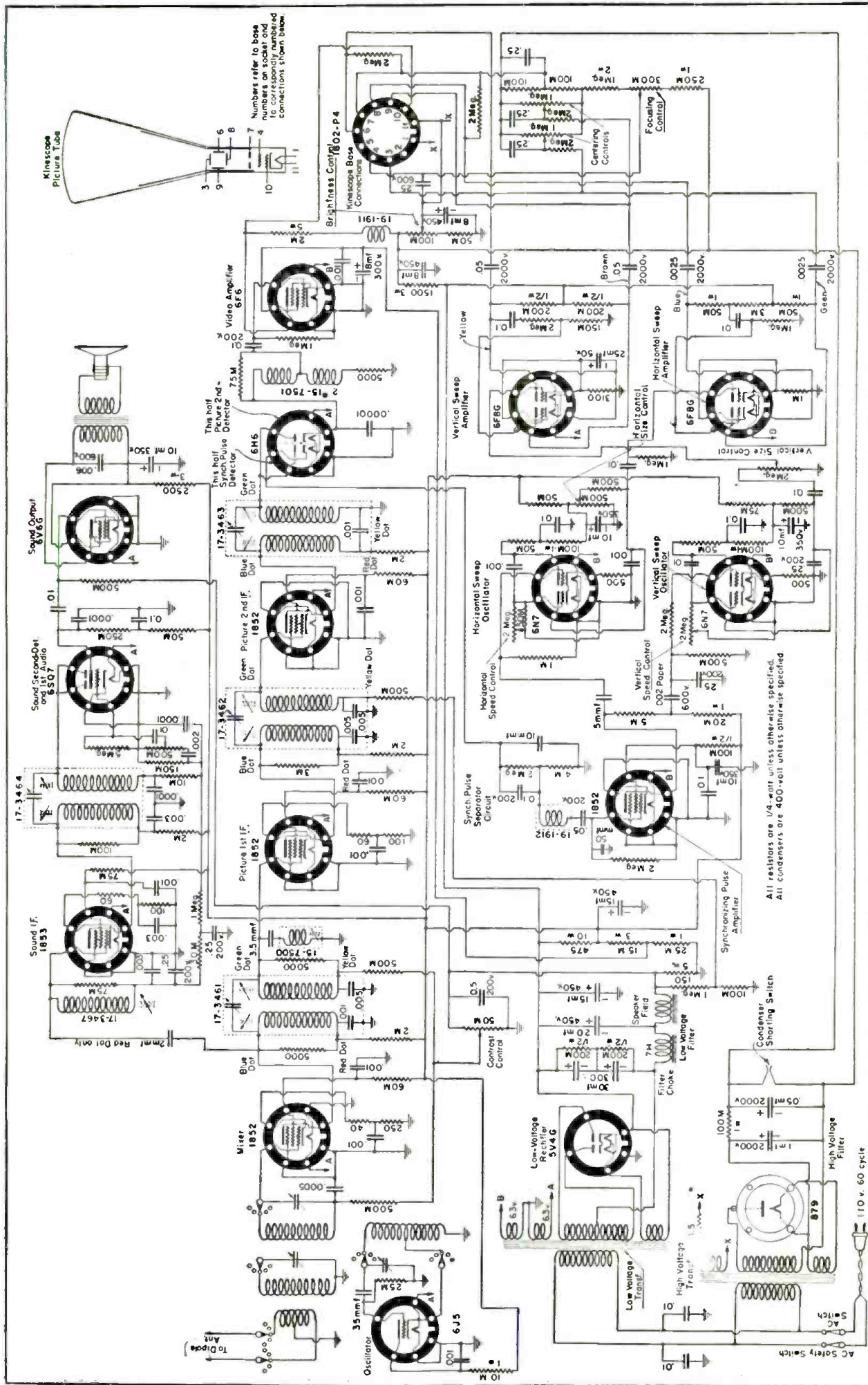

Fig. 1. Complete schematic diagram of the Meissner No. 10-1153 television receiver kit.

Receiver covers only the 2 lowest-frequency American television channels (44-50 mcgacycles and 50-56 mcgacycles), but has provisions for adding 2 additional channels when the need arises. The sound channel operates simultaneously with the image—when controlled—serving to tune both channels. The sweep circuit oscillators are plished through the aid of synchronizing pulses transmitted between successive lines and frames of the image.

Mr.

SERVICEMAN PUBLIC ADDRESS MAN SOUND SPECIALIST

FREE *Consultation*

and Design Service!

COMMENCING with the January, 1940 issue, *Radio-Craft* opens an entirely new department devoted exclusively to the interests of Servicemen, P.A. men, sound specialists, and men contemplating entering these fields. Whether you want a special amplifier designed, difficult problems in past and future P.A. installations solved, enlightenment on audio frequency theory, or anything at all in connection with Sound, simply write to:

SOUND EDITOR,
c/o *Radio-Craft*,
99 Hudson St.,
New York, N. Y.

. . . and enclose a stamped and return-addressed envelope. Write plainly, on one side of a sheet only, and include explanatory diagrams wherever possible.

Servicemen contemplating entering the P.A. field should not hesitate to write for advice concerning their initial installations. This consultation and design service has no restrictions as to scope. If you wish a design for a special frequency-compensating network; special input, output, coupling, and interstage circuits and transformers, etc., it is yours for the asking. All circuits so designed will actually be constructed and tested in the laboratory to guarantee reliable operation.

This service is absolutely free of charge to our subscribers. If you are not a regular reader now, we suggest that you take a year's subscription immediately in order to take advantage of this valuable service.

The new department will be conducted by Mr. A. C. Shaney, one of the foremost sound engineers in the radio field—the same Mr. Shaney whose many interesting and informative articles in *Radio-Craft* have received world-wide acclaim.

The Editors

NOTE: We would appreciate receiving your comments regarding this new department—especially comments on how we can improve its service and scope. These comments are welcome from all readers, whether subscribers or newsstand readers. Let's get off to a good start with this new department.

3rd GROUP of PRIZE WINNERS

Radio-Craft's P.A. Contest

Servicemen, radio dealers and sound specialists are also given the article which won the 2nd Prize in the Third Section of RADIO-CRAFT'S \$4,000 P.A. Contest. This winner's contribution shows why "most churches need public address systems", and how to "sell" this market.

1ST PRIZE—"Filmgraph" Model A, \$149.50.

Offered by Miles Reproducer Co., Inc.

Won by Hobard W. Troop, 1877 Dorchester Ave., Dorchester, Mass.

2ND PRIZE—Audio-Spectrum Control Add-On Unit, type ACA-ASC, \$100.00.

Offered by Amplifier Co. of America.

Won by Wm. F. Bruening, 4354 Boyd Ave., Bronx, N. Y.

3RD PRIZE—15-18 W. Complete P.A. System, \$89.50.

Offered by Radio Wire Television, Inc. (Formerly Wholesale Radio Service Co., Inc.)

Won by T. B. Paltridge, Queensland Agricultural High School & College, Lawes, Queensland, Australia.

4TH PRIZE—25 W. De Luxe Amplifier, type AM-25, \$71.

Offered by Amplitone Products Co.

Won by Mahlen Moore, Midland Senior High School, Midland, Mich.

5TH PRIZE—20 W. Amplifier with shield and tubes, ready to operate, type 32-20C, \$64.00.

Offered by Vocagraph Sound Systems.

Won by Chas. S. Moore, 716 Main St., Pineville, La.

6TH PRIZE—30 W. High-Gain Amplifier, with tubes, ready to operate, \$62.90.

Offered by Radolek Company.

Won by M. Asch, Radio Laboratories, 117 West 46th St., New York, N. Y.

7TH PRIZE—Velocity Microphone, type RBHK, \$42.00.

Offered by Amperite Company.

Won by George Reiger, 3805 Mildren Way, Hollidays Cove, W. Va.

8TH PRIZE—Baffle, type B-5, \$36.00.

Offered by Fox Sound Equipment Corp.

Won by Don M. Ellis, Box 481, 618 W. Chapel, Santa Maria, Calif.

9TH PRIZE—Airline Velotron Microphone, \$32.00.

Offered by Montgomery Ward & Co.

Won by Luther B. Hoffman, 678 Princeton, Palmerton, Pa.

10TH PRIZE—Bruno Velotron Microphone, \$27.50.

Offered by Allied Radio Corp.

Won by William H. Wise, 606 Olds Tower Bldg., Lansing, Mich.

11TH PRIZE—Auto-Top Carrier for Mobile Sound Installations, platform size 30 x 54 ins., type PA26, \$22.50.

Offered by Vac-O-Grip Company.

Won by Thomas Acas, 208 Alder St., Waterbury, Conn.

THIS IS THE SECOND-PRIZE MANUSCRIPT*

MOST churches need public address systems. Many have poor acoustics, the preacher having difficulty being heard in the rear of the church because of outside noise, etc. Many other uses suggest themselves for churches and this field seems to be one worth going after. Public Address work is a hobby of mine and my own church has made good use of the system which I have installed. Among the uses to which our church has put public address are the following: (a) boosting the preacher's voice so that it can be heard clearly in all parts of the church in spite of the noise coming through open windows; (b) amplifying the sound of a small reed organ in the Sunday School room so that it can really lead the singing of a larger group of people; (c) helping speakers to make announcements, etc., at public social functions; (d) amplifying services held outdoors on the church lawn in summer; (e) amplifying the chimes in the organ tower through speakers in the church tower so that they can be heard throughout the community;

(f) boosting the output of the electric organ (an Orgatron).

A demonstration sold the idea of P.A. to the church for the first purpose mentioned above—boosting the preacher's voice and thus improving the acoustics of the church. Using a small 5-watt amplifier that I happened to have on hand, the church Board readily saw the advantages of having such a system for permanent use. Other uses were also found and gradually the entire system outlined below was acquired.

On the equipment which our church now has, a profit of \$200 would easily have been possible had I charged what the equipment was actually worth and

not donated my time as a contribution to the church.

Our present installation consists of three units:

(1) A small 12-watt portable system (home constructed) which is used for purposes mentioned above under (a), (b), (c). Cost \$35 to \$50.

(2) A 30-watt (home constructed) amplifier which was originally used for outdoor gatherings but which has now been converted into an additional "booster" for the "Everett Orgatron." Cost about \$125.

(3) A 70- to 100-watt amplifier with two 40-watt speakers used to amplify
(Continued on page 305)

*The 2nd-Prize manuscript runs considerably beyond the requisite 500 words but was allowed because of the exceptionally ingenious installation it describes. It will therefore run as a complete article in the following (December) issue of Radio-Craft.—Editor

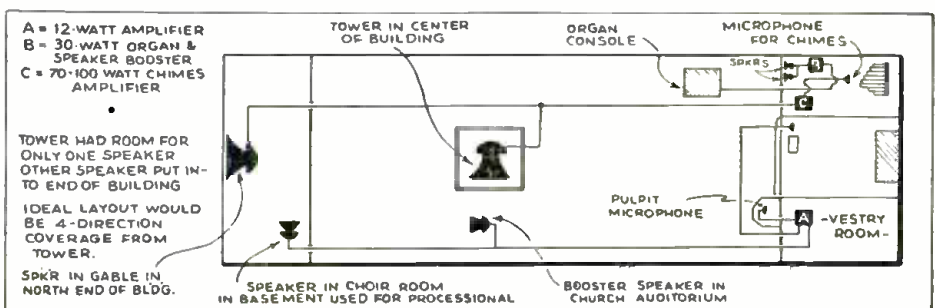

Layout of the P.A. system in the local church of the 2nd-Prize winner, Wm. F. Bruening.

ALL-PUSH-PULL DIRECT-COUPLED

"Packaged engineering" applied to a basic sound amplifier now enables or more of a large number of important features—90% of which, Mr.

A. C. SHANEY

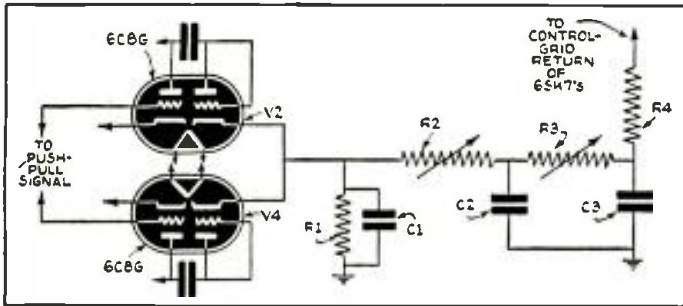

Fig. 1. Full-wave diode rectifier of expander.

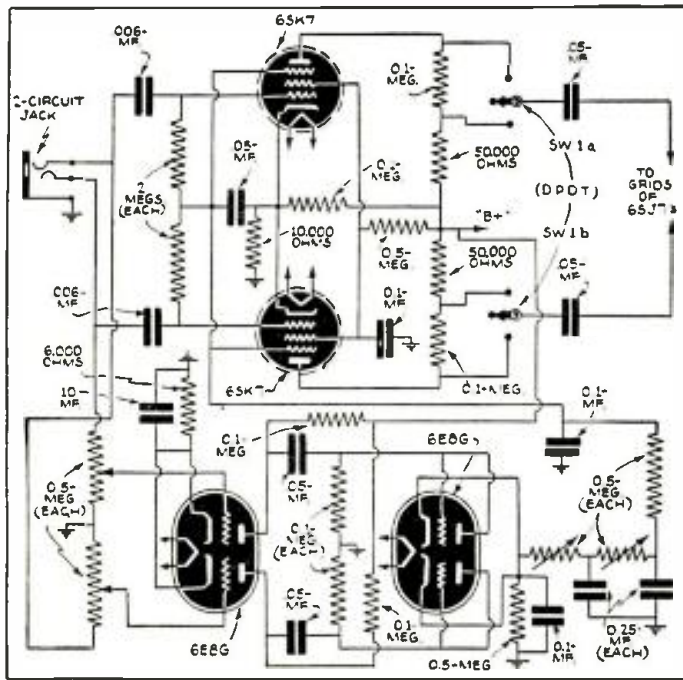

Fig. 3. Non-overloading push-pull expander with variable time delay.

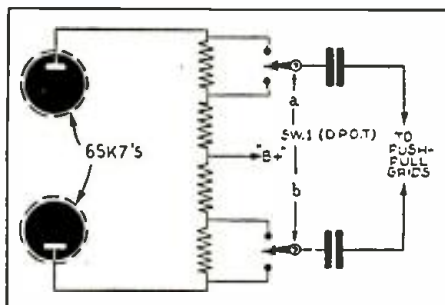

Fig. 2. Losser circuit in expander plate output. Note that the switch sections (A&B) of Sw.1 operate simultaneously, either towards both plates (no loss) or towards "B+" (12 db. loss).

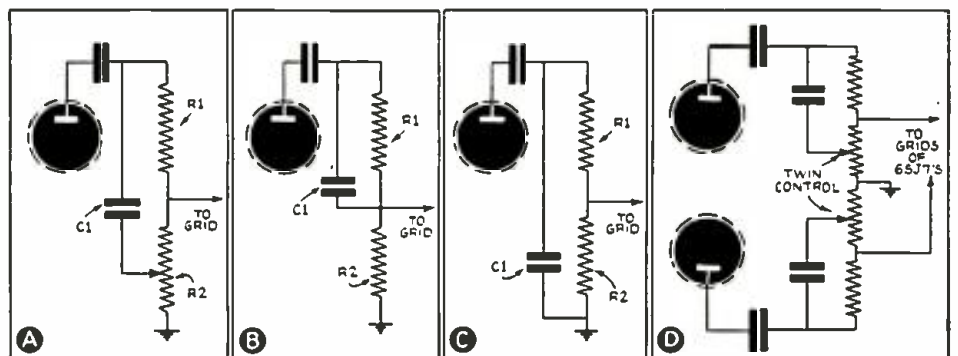

Fig. 4. At A—basic H.F. circuit. B—H.F. accentuation. C—H.F. attenuation. D—Push-pull H.F. equalizer.

THESE features provide for the first time, a practical system of "packaged engineering," whereby any one or more of the following 14 available features can be added to the popular 30-Watt Direct-Coupled Amplifier.

- (1) Variable Speed Non-Overloading Push-Pull Expander
- (2) High-Frequency Accentuation and Attenuation
- (3) Low-Frequency Boost and Cut Control
- (4) Push-Pull Automatic Volume Compressor
- (5) Push-Pull Automatic Volume Limiter
- (6) Push-Pull Automatic Volume Control
- (7) Non-Frequency-Discriminating Scratch Suppressor
- (8) Additional Low-Gain Single-Ended Input
- (9) Additional High-Gain Single-Ended Input
- (10) Additional Low-Gain Push-Pull Input
- (11) Additional High-Gain Push-Pull Input
- (12) Audio Spectrum Control
- (13) Calibrated Volume Indicator
- (14) Remote Control

A review of the design of the Direct-Coupled Amplifier described on page 202 of the October, 1939, issue of *Radio-Craft*, will coordinate the description of the features to follow; although this amplifier is being used as a basic design, these features may also be added to most other amplifiers—depending, in part, upon the individual feature selected, and the available amplifier.

WHY NOT DIRECT-COUPLED THROUGHOUT?

The question was raised in our laboratories as to the advisability of designing the additional features in such a manner as to permit direct-coupling between the auxiliary feature and the amplifier proper. The design problems encountered, however, in following such procedure, make it obviously impossible to economically maintain the ease with which these auxiliary features can be added through a standard resistance-condenser coupling method. If the auxiliary features were to be direct-coupled into the main amplifier, a different design would have to be worked out for each particular combination. As there are over 14 individual features, which make a total possible combination of nearly 16,000 different variations, the inadvisability of designing so many different types of amplifiers is quite apparent.

With the conventional method of coupling between the auxiliary features and the amplifier proper, it becomes

Modern Features to the

30-WATT P. A. AMPLIFIER

any public-address specialist to incorporate in a suitable amplifier one Shaney believes, have never before appeared in any radio magazine!

PART II

feasible to standardize on the 2-stage direct-coupled amplifier unit, and provide suitable heater and plate voltages for any one or more auxiliary features. The extraordinary flexibility of this arrangement more than compensates for any advantages in maintaining direct-coupling throughout the input stages. Furthermore, it is comparatively simple to design a wide-range low-level input stage. As these stages or auxiliary features are to be designed for push-pull operation, it becomes a relatively simple matter to outperform any existing types of standard single-ended circuits.

THE VARIABLE SPEED NON-OVERLOADING PUSH-PULL EXPANDER

During the past few years, volume expansion has received a considerable amount of attention from design engineers. Its practical application, however, has not attained the wide popularity that it deserves, because of the following 4 reasons:

1.—Individuals who have never heard volume expansion, find it very difficult to imagine this type of circuit operation, and unless it is actually demonstrated, it is rather difficult to sell.

2.—The usual type of volume expansion incorporates a *fixed* time delay. This limitation makes it definitely unsuited for the wide variety of recordings that may be used, because of the fact that expansion for reproduction of slow and rapid tempo music, requires different timing.

3.—Expanders which have been successfully applied, invariably produce overload distortion because the peak power of the amplifier is incapable of adequately handling the full power out-

put at points of maximum expansion.

4.—Nearly all commercial expanders are of a single-channel type, and because of their pentode-type construction, introduce an appreciable amount of even-order harmonics, which are carried on through the output of the amplifier.

The expander developed for this 30-Watt Direct-Coupled Amplifier, eliminates all of these objections and places before the music lover an outstanding development to enhance all types of recordings.

The difficulty of making people understand the value of expansion is most effectively circumvented by an actual demonstration. A complete description of *why* an expander should be used, will be found in the April, 1938, issue of *Radio-Craft*, page 76, under the paragraph heading "Why An Expander Should Be Used."

The value of incorporating a *variable* time delay is quite apparent. The usual practice has been to use a delay of approximately $\frac{1}{4}$ of a second. While this may be a good average setting, it is certainly inadequate for proper expansion of "jitterbug" records. On the other hand, a slow symphony with slowly rising swells, should have a slower acting expander to smooth the rate of expansion and more nearly complement the recording engineer's monitoring.

THE TIME DELAY CIRCUIT

By referring to Fig. 1, it will be noted that the resistor-capacity filter system feeding from the diode rectifier has a variable resistor network. As the time constant of this filter is a function of the variable resistors R2 and R3 it

(Continued on page 302)

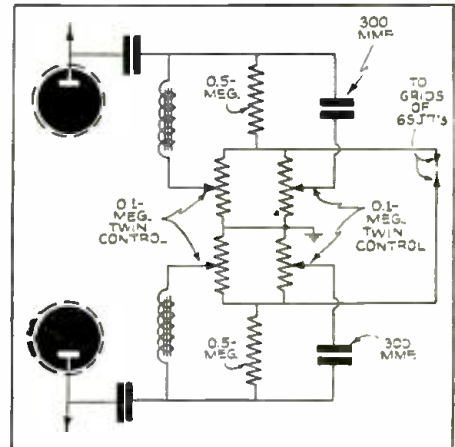

Fig. 6. High- and low-frequency equalizers.

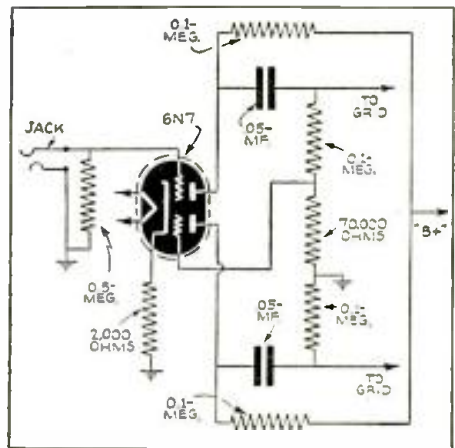

Fig. 7. Low-level inverter.

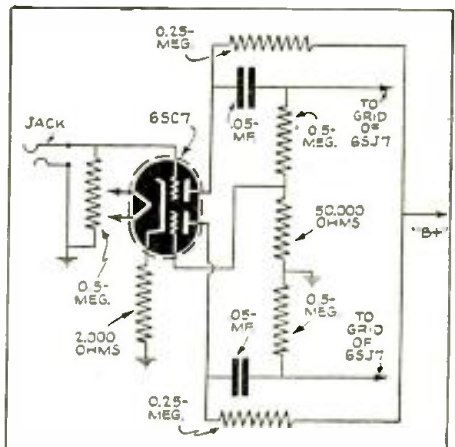

Fig. 8. High-gain inverter.

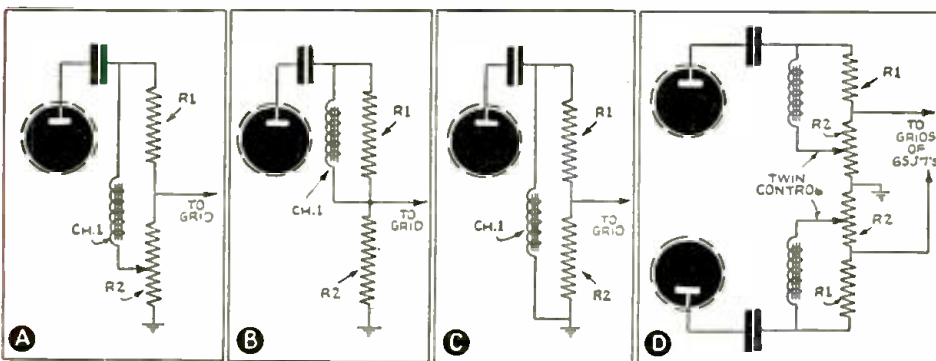

Fig. 5. At A—basic L.F. circuit. B—bass boost. C—bass cut. D—Push-pull L.F. equalizer.



Scene in temporary television studios in first 2-way 441-line wire-television demonstration. "Jeep" control at right.

2-Way Telly Demonstration

The RCA demonstration of 2-way wire-television at an Atlantic City hotel, last month, introduced use of the "jeep" control shown at extreme right in the above photo.

“WELL, I declare! Hello, Andrews,” exclaimed Dr. John W. Studebaker, U.S. Commissioner of Education, in greeting Elmer F. Andrews, Federal Wage and Hour Administrator, by wire-television last month. The two distinguished gentlemen were enabled by the wizardry of electronics to simultaneously see and hear each other.

This practical demonstration by RCA Manufacturing Co. of the possibilities of 2-way wire-television between 2 studios in the Ambassador Hotel in Atlantic City, N.J., was also participated-in by executives of many broadcast stations. Dr. Studebaker, who said the future pos-

sibilities of television in education “seem limitless,” was amazed. Broadcast stations and large department stores however feel that point-to-point wire-television has more immediate application than broadcast radio-television, and therefore, approximately 20 of the former group have signified their desire to install set-ups of the general type employed in the demonstration; to station KSTP, St. Paul, Minn., goes the honor for signing-up for the first unit, for use in demonstrations of modern 441-line, high-fidelity television.

The 2-way demonstration was carried out with a duplicate equipment of the same type in use at the San Francisco

and New York Fairs. Each participant stood before a television receiver under a battery of lights. Behind the receiver, and facing him, was a television camera and microphone. The camera picked up the image of each participant and relayed it to the receiver before the other. In a viewing room adjacent to one of the temporary studios, television receivers placed side by side showed both images and made both voices audible.

This procedure is shown in the photo at the top of this page which depicts a scene in the temporary television studios set up by RCA in the hotel. The viewer watches the image of a friend on an-

(Continued on page 316)

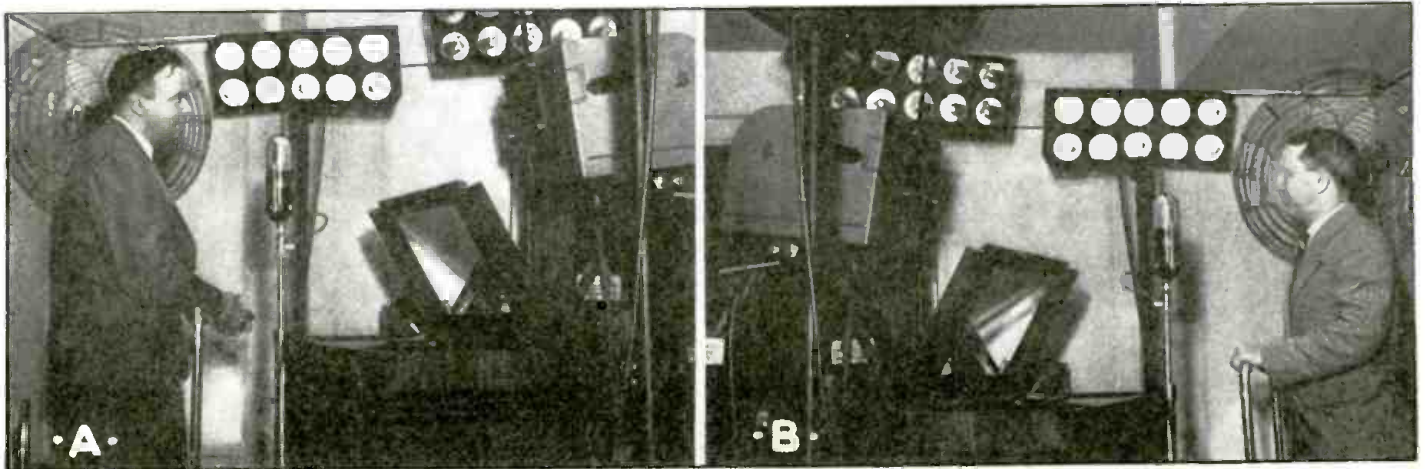

A—Elmer F. Andrews, Federal Wage and Hour Administrator, and B—John W. Studebaker, U.S. Commissioner of Education, in separate studios, see and hear each other.

How to Build a "Junkbox" ELECTRIC GUITAR

If, like author Chambers, you have had a "yen" to own an electronic music instrument, you probably will be interested to learn how amateur operator W9BMN constructed an electronic guitar, complete with pickup and amplifier, at almost no cost, by using spare parts.

FRANK E. CHAMBERS, W9BMN

EVER since those instruments of torture known as electric guitars made their appearance to crucify the ears of aesthetic musicians, I have had a yen to own one. Not that I am in favor of crucifying musicians, you understand; —at least not all of them!

However, one large fly was present in the ointment—the cost! What with buying new gadgets for the rig, corsages for the girl friend, and an occasional pair of Sox for myself, the state of the personal exchequer was in precarious straits. I could amplify this statement, but most hams will know the feeling.

The "junkbox," however, was in good shape; so good that some grumbling had been heard anent the amount of room required to store the treasures, some relics of 15 years a ham, and other more recent acquisitions. But a survey seemed to indicate that about everything needed to build the amplifier and pickup for the guitar could be taken from this storehouse of retired radio parts.

The guitar itself was of rather ancient vintage, and had a pleasant tone, but was very anaemic, and unable to lift its voice above a whisper. It, like myself, was battle scarred, and beginning to feel its age. But I figured that an amplifier would bring the tone up to where it could be heard above the blare of the neighbor's radio, and since completion, I am so satisfied with the result, that I thought some of the other boys might be interested in the details.

The first thing was to decide on what type of pickup to use, and this soon boiled down to the electromagnetic type, as the crystal pickups cost too much, and I was rather dubious about using an electrostatic type, which would be f.b., but would require the first amplifier stage to be built into the guitar itself, and I anticipated difficulties in running the output of this stage into the main amplifier as the filament leads for this stage would be of necessity, run through the same cable that would carry the output to the main amplifier, and that looked like a hum problem to me. So the magnetic type was chosen, and has worked out very nicely.

The amplifier was built into an old mantel type set, which originally used a pair of 45's in parallel, and was in the junkbox, minus a speaker. Most of an old Majestic 90 was there, and the speaker from the 90, with its input and output transformers, was used. The circuit used is given in Fig. 1. This, of course, is not the only way to build the amplifier,

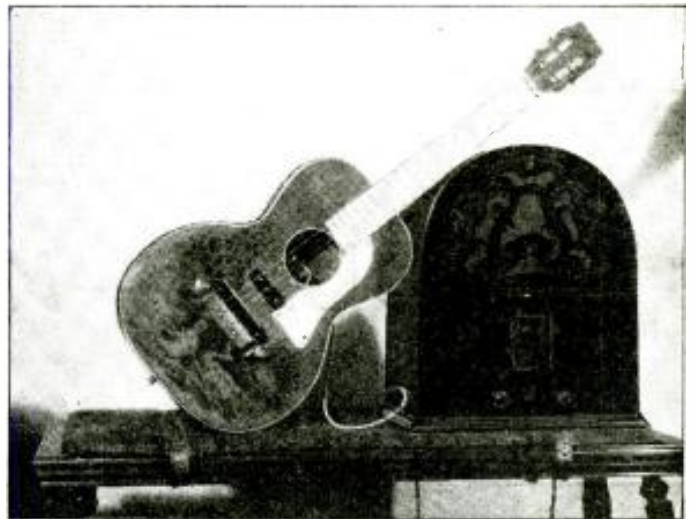

The old anaemic guitar has been brought up-to-date and is here shown being used in conjunction with an ordinary home receiver. Its tunes are reproduced electrically now.

and certainly is not the best way, but it suited the parts on hand best. If a single output tube is used instead of push-pull, 2 high-gain stages can be used ahead of the output stage, and using a 6L6 output, it might be possible to get enough grid drive with only 1 pentode stage ahead of it. However, use what you have; I did. The first tube is a 57, because the power supply in the set had a 2½-volt filament supply, and I had a 57, which also helped. This was originally resistance-capacity coupled to a 56 which was coupled to the 45's through the input transformer, but the gain was not quite enough, so the second 56 stage was added. Likely a 53 as
(Continued on page 308)

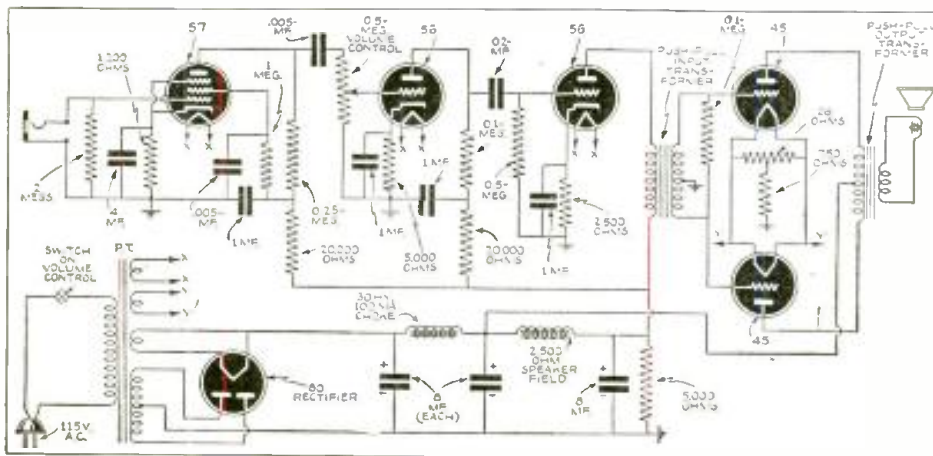
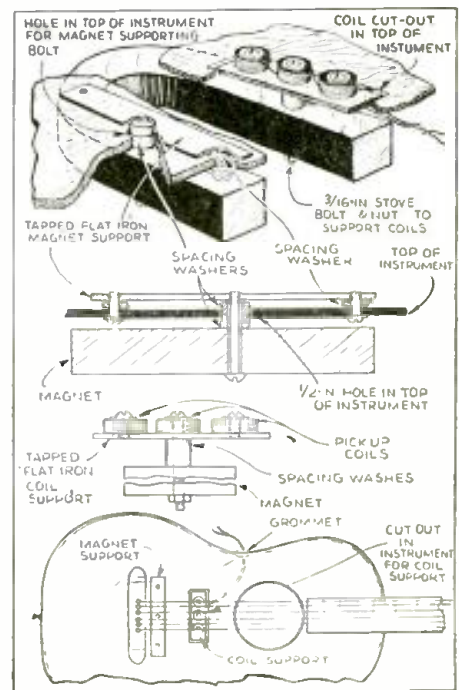
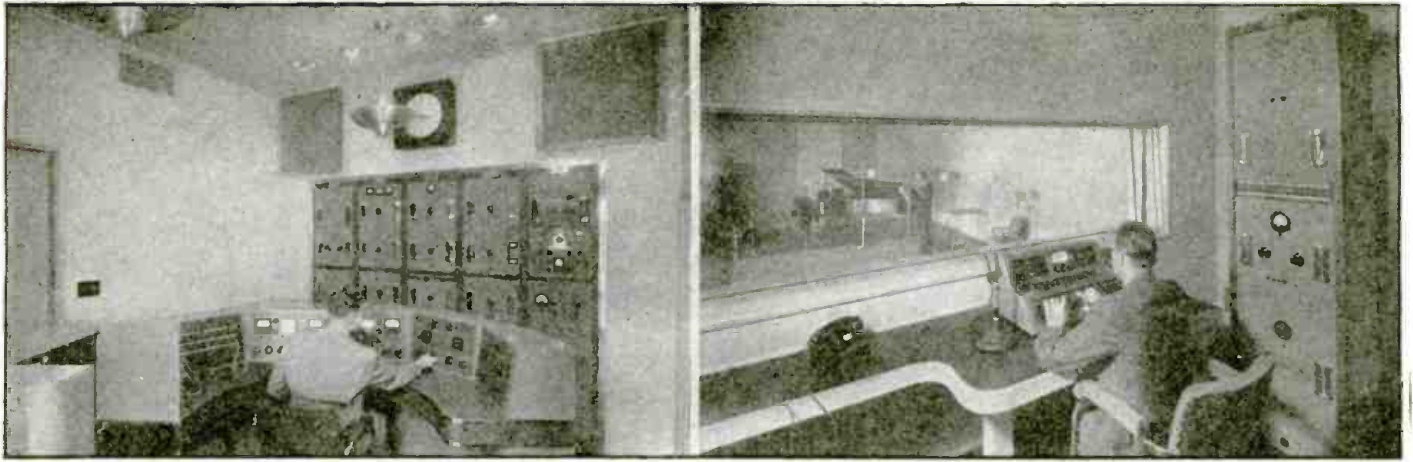

Fig. 1. Schematic diagram of an amplifier suitable for use with the electric guitar.

Showing the construction of the pickup units and their location on the guitar with respect to the strings.





All the radio and public address facilities (including an emergency power plant) on Treasure Island at the San Francisco World's Fair were installed by RCA. Of the 5 studios provided (2 for audiences), the largest one cost \$400,000 and seats 3,400 persons, and all studios are centrally controlled; a master control can handle 12 outgoing releases at one time. Transcribing and recording facilities are available. The 50 "Cubicle" loudspeakers, which cover all principal courts and main thoroughfares, each have their own local power amplifier. Above, left—radio master control room and operator. At right—one of the studio setups, viewed through a local control room.

SOUND—Vital Factor at Both World's Fairs



SOUND specialists and Servicemen unable to attend either the West- or East-coast World's Fairs we feel sure will be interested to know a few of the new ways in which sound equipment is being used at these fairs. Some examples of these applications are here shown and described.

It is interesting to note that it was

the experience with past fairs—including Cleveland, Chicago, Dallas, and San Diego—which resulted in the decision to provide exceptional radio and public address facilities at the San Francisco World's Fair. By preselect arrangements, from the master control speakers, units may be automatically switched from one channel to another, as circum-

Part of the Western Electric sound equipment used for the "Railroads on Parade" show at New York World's Fair. The W.E. 4-channel affair includes 19 separate amplifiers, plus rectifying equipment. Six 31-in. loudspeakers on the stage are so located and used as to give stereophonic reproduction!



▲ One of the many loudspeaker outlets at the New York World's Fair; the perisphere and trylon theme in the background adds an artistic touch to this view. A single Cinaudagraph cone-type loudspeaker is mounted in a double baffle so that both front and rear sound waves of the speaker are utilized. (The 3 circles shown on pole at the left are decorative lights.)

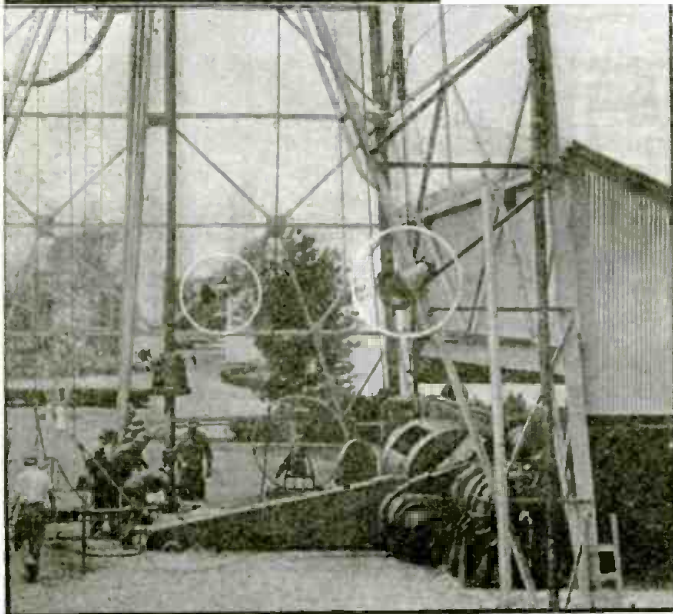

◀ From these 2 RCA loudspeakers on the oil derrick outside the Petroleum Exhibit (N.Y. Fair) the operation of the drilling mechanism is explained to visitors daily. Workmen are shown lowering the drilling bit for demonstration. Electrically amplified sound is a vital factor at both World's Fairs. It permits larger audiences to appreciate more fully the interesting and educational exhibits and affords the exhibitors the best possible returns for their investments.

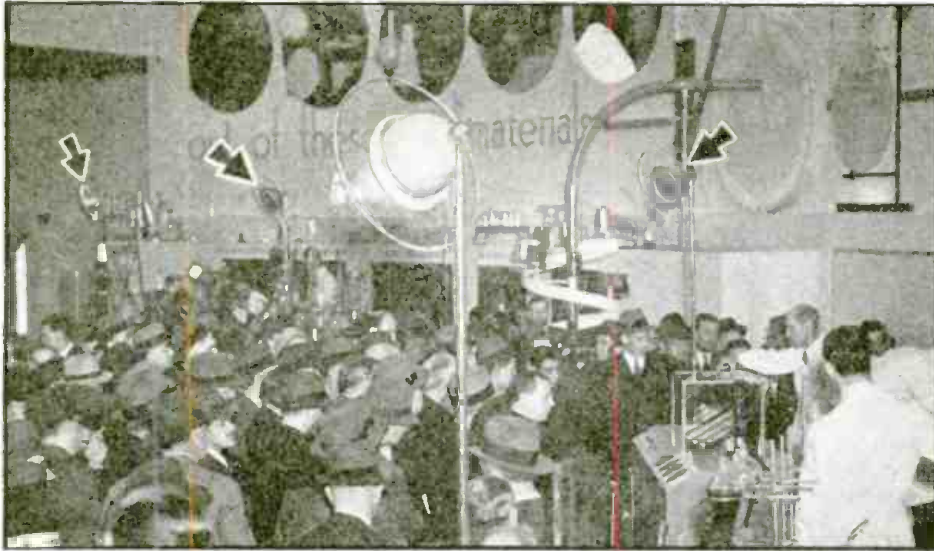

High voice quality and unusual decorative effects are achieved in the loudspeakers at the Du Pont Exhibit at the New York World's Fair; specially-designed speaker housings incorporate baffles of crystal-clear, unbreakable "Lucite" (a methyl methacrylate resin plastic). Of the 4 of these speakers shown above, arrows mark 3. Individual amplifiers, lapel mikes, and these speakers, enable the exhibit's lecturers to address, without either voice strain or fatigue, large groups.

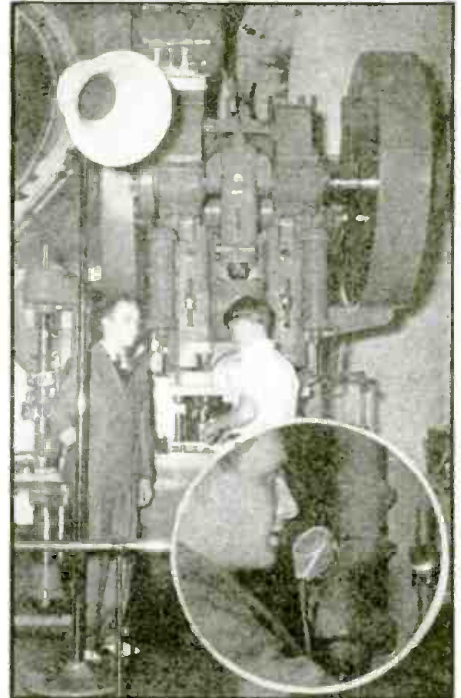

The Ford Exhibit, like most of the others at both the New York and San Francisco World's Fairs, makes extensive use of modern public-address equipment for conveying to large audiences the interesting information concerning the manufacture of automobiles. Ford utilizes 2 distinct sound systems, one for public address and the other for its electrical musical instruments. These latter consist of 4 Hammond Novachords and the Hammond Organ.

stances may require. Time switches are provided to turn the speakers on and off.

At the New York World's Fair, in the "Railroads on Parade" show, all acting on the tremendous stage is done in pantomime because direct pick-up of speaking parts from the stage would be impractical. Sound engineers solved the problem of giving voices to the actors by using a public address system to synchronize stage action with dialogue and musical accompaniment originating in a specially-built sound room beneath the grandstands.

Cinaudagraph Corp. contributed considerably to the success of the New York World's Fair.

The Petroleum Exhibit at this Fair owes part of its success to a properly-installed RCA P.A. system.

Du Pont showed how the plastics industry can dress-up sound equipment.

The new 40-watt "Twin Power" loudspeakers of RCA and the 50-watt "Coaxial" speakers of Langevin received "shake-down" tryouts at the Fairs.

Ford Motor Co. spared no expense in applying sound to its exhibits.

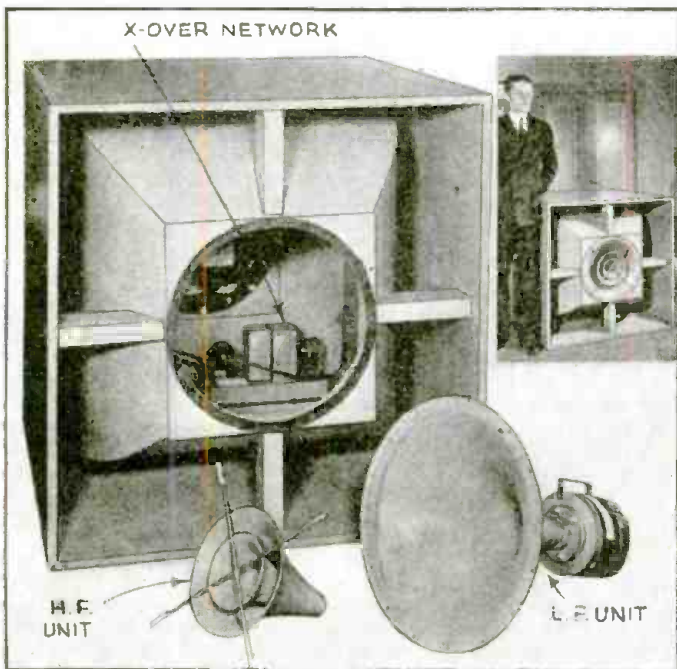

▲ The RCA "Twin Power" high-fidelity loudspeaker. A high-frequency horn unit points out the front; a second, powerful, low-frequency loudspeaker unit is directed toward the rear. There are 52 of these P.M. dynamic speakers at the San Francisco World's Fair; 45 at the New York World's Fair (12 in the periphery—see June '39 *Radio-Craft*, pg. 720). Speaker weighs 224 lbs.; rating, 40 W. (continuous). Frequency range is 60 to 10,000 cycles; crossover is at 650 cycles. In photo, note L.F. unit above x-over network; the H.F. diffuser, lower-left, fits into H.F. unit, lower-right, as shown in insert-photo.

This is one of the new Langevin 31-in. coaxial loudspeakers (part of an extensive Western Electric sound system) mounted backstage of the "Railroads on Parade" Exhibit at the New York World's Fair. A similarly constructed speaker (shown on front cover), 60 ins. wide, is mounted on top of the Railroad Building for ballyhoo purposes. This 2-Unit Coaxial, Multi-Cellular Horn incorporates a low-frequency unit driven by a Jensen 18-in. dynamic speaker; and a W.E. type 551-W H.F. unit. Vanes diffuse the high frequencies.

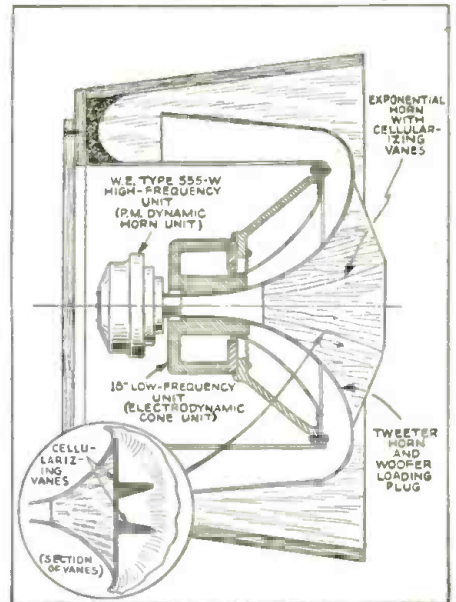

➤ Cross-section of the Langevin 60-in. loudspeaker atop the Railroad Building at the New York World's Fair. Consisting essentially of low- and high-frequency units, the latter with a multicellular "honeycomb" for radiating the sound in all directions, the speaker affords excellent distribution over a vertical and horizontal angle of about 70 degrees. The mouth of the low-frequency unit is 5 ft. on each side. Both units are mounted coaxially, avoiding phase difference. The speaker is rated at 50 W. for continuous operation.

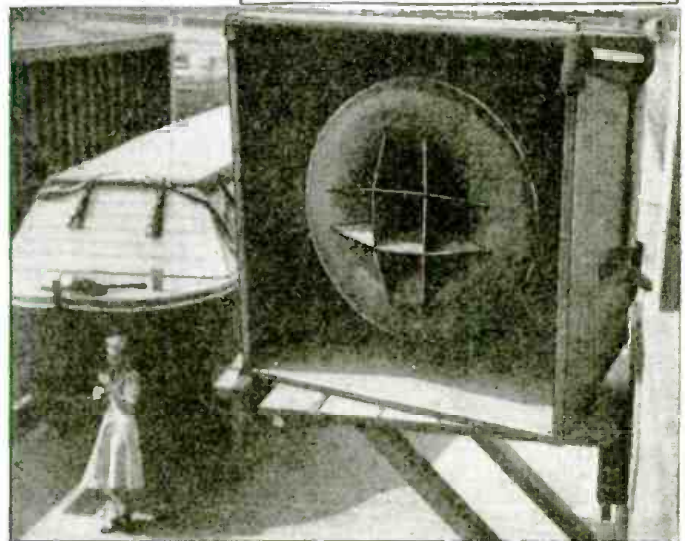

Review of F.C.C. Allocations of Ultra-Shortwaves

Recent changes in F.C.C. regulations have an important effect upon radio equipment. It is important, therefore, that manufacturers and technicians familiarize themselves with these new regulations, and variations from previous practice, as described in this Review.

THE Federal Communications Commission recently issued a report covering the allocation of frequencies throughout the radio spectrum from 30,000 to 300,000 kilocycles. (The Commission also made public the table of allocations to the specific services.)

In addition to announcing various changes in the allocation to these specific services, the report:

(1) Extends existing permits for frequencies above 60,000 kilocycles except those operating in the broadcast service (television, facsimile, relay, high-frequency and experimental broadcast) to Oct. 1, 1939.

(2) Provides that applications for renewal which are due to be filed on Aug. 1, 1939 shall specify frequencies in accordance with the new allocation.

(3) Provides that applicants for new permits after the effective date of this order (April 13, 1939) shall request frequencies in accordance with the new table of allocations.

BROADCASTING

The allocation of frequencies above 30,000 kilocycles vitally affects several important broadcast services; namely, *television, facsimile, relay, high-frequency and experimental broadcast*. All outstanding authorizations for television service are experimental.

The same 19 bands acted upon by the Commission Oct. 13, 1937 are reserved for television; however, 3 of the bands, namely, 162,000-168,000 kc., 210,000-216,000 kc., and 264,000-270,000 kc., may be used also for general or specific research and experimentation in the radio art along lines which are not specifically directed toward any established service. These stations will be required to vacate these bands if operation thereon results in interference to any television station.

(The Commission believes that *in order to permit television to be inaugurated on a nationwide basis* a minimum of 19 channels should be reserved below 300 megacycles. This does not mean that the minimum number of channels allocated by this order will eventually provide channels for a completely competitive nationwide service. Undoubtedly additional channels above 300 megacycles or some rearrangement of the present plan will be necessary at a later date.)

In the band 41,000-44,000 kc. 75 channels are made available for assignment to aural broadcasting and facsimile broadcasting stations. Of these, 25 channels have already been allocated to non-commercial educational broadcast stations. The revised order does not change the existing broadcast allocation in this band nor does it change the allocation to broadcasting on frequencies below 41,000 kc.

Order 19 originally provided for broadcasting in the band 142,000-144,000 kc. In order to provide frequencies for the aviation service, it was necessary to shift broadcasting to the band 116,000-118,000 kc. which was formerly tentatively assigned to amateurs.

Frequencies will be provided in each of

the broadcast bands above 40,000 kc. for experimentation in *frequency modulation* as well as *amplitude modulation* in order that the relative merits of the two types of modulation may be properly evaluated by the Commission at an early date. It is anticipated that as a result of such experimentation proper standards will be eventually developed.

The action of the Commission in revising Order 19 provides a total of 12 channels for broadcasting service, such as, for example, relay broadcasting, in the frequency band 132,000-140,000 kc. These channels are in substantial accord with the original allocation.

POLICE SERVICE

The police service has been allocated 8 channels between 132,000-140,000 kc. to supplement the frequencies which have previously been allocated to this service within the band 30,000-40,000 kc. At the present time there is only a small number of police stations operating experimentally above 100 megacycles.

Municipal and county governments as in the past will be required to cooperate to the fullest extent and coordinate their needs for radiocommunication service in order that interference may be minimized. These frequencies will be maintained experimentally until such time as developments may determine in which manner they may be best used by this service.

AVIATION SERVICE

In order to provide additional frequencies for the aviation service, which is essentially a safety service, and may not be served by any other method of communication, the frequency band 140,100-143,880 kilocycles has been allocated to this service. *Many of the present problems which confront the aviation industry through its employment of medium frequencies may be solved through the use of the ultra-high frequencies.* These frequencies are of utmost importance to the aviation service in that *these frequencies are comparatively free from atmospheric interference and electrical disturbances*, which render communication on medium frequencies impossible at times. Because of the natural limitations of these frequencies in their transmission and reception range, duplication of use of a given frequency will be possible at intervals of about 500 miles.

The frequency band 129,000-132,000 kilocycles remains unchanged and will be available for airport traffic control. Six airport frequencies separated by approximately 500 kilocycles will be available for use at various airports throughout the country. Where there are several airports in the same locality, such as New York, the use of a separate and distinct frequency may be authorized. The intervening guard bands are provided in order to avoid interference and thus give the maximum degree of safety possible.

FIXED SERVICE

The fixed service has been allocated 14 channels in the band 132,000-140,000 kilo-

cycles. In view of the decided and extensive demand for frequencies for the various classes of service which by their very nature are dependent on radiocommunication rather than wire lines, it is only possible to provide frequencies for the fixed service for use in areas where wire facilities are not available, or, due to circuitous wire routing or emergency circumstances, the use of radio may be found justified. Consequently, a limited number of frequencies have been made available for fixed service.

EXPERIMENTAL SERVICE

The experimental service has been allocated, in addition to the frequencies previously assigned, the shared use of those frequencies allocated to the special services. These additional channels which are interspersed throughout the frequency range 30,000-40,000 kilocycles and 132,000-140,000 kilocycles are primarily for general experimentation which is not directed specifically to any established service.

In addition, the order provides that all frequencies between 129,000 and 144,000 kilocycles are also available for assignment on an experimental basis to stations engaged in the development of a specific service in accordance with the rules and regulations governing that service. For example, should a municipality desire to experiment in the police service on frequencies above 130 megacycles, the frequencies allocated to the police service would be used.

There are also made available to the experimental service 3 bands of frequencies which have been allocated primarily for television broadcasting. These bands are separated approximately 50 megacycles apart, commencing with the band 162,000 kilocycles. Frequencies within these bands are available on a temporary basis only for general or specific research and experimentation in the development of the radio art along lines which are not specifically directed toward any established service. The holder of any general experimental instrument of authorization for any frequency or frequencies within these bands must vacate such frequency or frequencies if interference results to the television service. The assignments to experimental stations will be made upon the approximate 0.1% channeling system.

RELAY PRESS SERVICE

The term "relay press" station has been adopted by the Commission since Order 19 was first promulgated. Frequencies above 30,000 kc. formerly designated as "mobile press" are now designated "relay press." A relay press station is limited to the transmission of news for publication, or orders, instructions or inquiries concerning such news to be published by the licensee and other publishers of the same news, or to be disseminated by the news association with which the licensee is regularly affiliated. Licenses for relay press stations are granted for communication to or from points where other communication facilities are not available. The frequencies provided in the revised order for relay press stations

(Continued on page 311)



WANTS TRANSMITTER ARTICLES

Dear Editor:

Please publish a good XMTR job for phone on 10 meters, also to be used for 20 and 40 C.W. Would like to use a 6L6 tri-tet, 6L6 dbler and T20 final. Would like to grid modulate.

Please print a suitable diagram using a T20 for final and also speech end.

KENNETH S. BARR,
Wellington, Texas

Yes, some of our readers are interested in transmitters—but how many? If you would like to see constructional articles on transmitters and other Amateur Radio allied subjects, drop us a postcard. This is YOUR magazine. Tell us what you want in it. Don't make it necessary for us to guess.—EDITOR

AGREES WITH MOODY

Dear Editor:

I would like to lend whole-hearted agreement with Willard Moody's letter in the August issue. Surely the questions asked in the "Servicing Questions & Answers" columns are not sent in by capable radio Servicemen. The very nature of the questions would indicate that they were sent by screwdriver mechanics who shouldn't be trying to service sets.

Personally I like to get hold of the "tough babies". Every time I repair a tough-to-fix set, I find that I have learned something worthwhile.

Sprayberry's articles on new circuits are a real help to the Serviceman trying to keep up with the trade and the Shaney article on hum appearing in this issue is very interesting. Couldn't the pages devoted to service diagrams be used to more advantage? It seems to me that it is a terrible waste of space since we have to buy service manuals anyhow.

BOB STETLER,
Stetler Auto Co.,
Kingfisher, Okla.

Radio Service Data Sheets now ordinarily appear in *Radio-Craft* many months before they are published in manuals, and since they usually tend to highlight a trend or new development in radio, as for instance the first commercial use of certain new types of tubes, they serve as valuable references.

—Editor

DISAGREES WITH MOODY

Dear Editor:

I have been an ardent reader of your swell mag. since 1932 and have never had cause to complain until I read Willard Moody's letter in your August issue.

I protest strongly his saying the Servicing Questions & Answers are ridiculous. I have never written in myself, but the data one can file away on these Questions is both helpful and constructive. Mr. Moody should not figure we Servicemen are all Marconis like himself (or so it seems he figures, to judge by his letter). I've been in the game for 15 years and still have room for more knowledge.

I only wish you could find room for more of these helpful articles, including Operating Notes, Hints and Kinks. YOUR DATA SHEETS ARE GREAT, but unfortunately few. We Servicemen who do not have a flock of Chanalysts, etc., appreciate such articles as written by Charles R. Leutz, S. West, Harry Paro, Sanford Miller, and F. L. Sprayberry in this August issue. The only "kick" I have is the change in your mag. cover. It used to be easy to run your finger down the pile and find the issue you wanted, now, with no Date, or Month on the end binding, one has to get the whole stack down to look on the front cover.

Hoping you will give us more of the Television Servicing articles and keep up the good work for us "Ditch Diggers".

R. H. CHERRILL,
Cherrill's Radio Electric,
Phila., Pa.

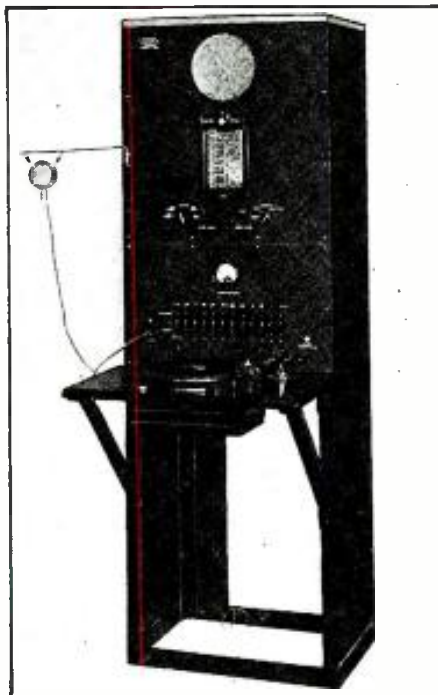

The apparatus installed in an Australian school by Mr. J. W. Love of that country. He tells of the installation, in this department.

RIDER "CHANALYST"

Dear Editor:

You ask for comments on the Rider "Chanalyst". I think it hits the nail on the head. I have been using a similar method for a considerable time but with a half-dozen different units, a carborundum detector, etc.; but using sockets to cut into place instead of prods. I think the new instrument will go over big, and congratulate Mr. Rider on producing something worthwhile. I am hoping your magazine keeps up its present style; two others that I have subscribed to for years have fallen by the way-side.

WM. PICKERING,
Vancouver, British Columbia.

RE. MOODY AGAIN

Dear Editor:

I am a reader of *Radio-Craft* and I ran across an article by Mr. Willard Moody, and would like to explain in 5 articles (below) why we appreciate your magazine. I would also like to state that Mr. Sprayberry has some good articles but the articles are such that we have not come across a radio set in our community where we have had to look them up (and I have all the *Radio-Crafts*).

1.—We can't get our knowledge by going down the street to see a jobbing expert radiotician.

2.—Haven't got wholesale firms next door to buy from.

3.—Can't pick up diagrams and wiring circuits like they can at a moment's call.

4.—Parts are limited and we have to order them, mostly by mail.

5.—We like *Radio-Craft* for the Data Sheets, Service Notes, Operating Notes, Useful Kinks and Circuits, New Tubes—and more of them.

I have serviced in large cities but when I started in a Podunk town I hardly made the second grade as far as real servicing was concerned and found it altogether different.

M. E. ARMSTRONG,
Austin, Minn.

TIP ON SPARTON SETS

Dear Editor:

Regarding Sparton receivers blowing power tubes discussed in March *Radio-Craft*, be advised this is mainly due to heavy plate current. The large carbon bias resistor used as original equipment changes value often to a figure as low as 400 or 500 ohms. Change to 1,250 ohms, 10 watts, wire-wound, and except in extreme cases, where high line voltage is encountered, the trouble is definitely cured. High line will cause short life for the type 485 tubes as well.

J. O. ROBERTS,
Roberts Radio Service,
St. Louis, Mich.

AUSTRALIAN SCHOOL P.A.

Dear Editor:

I have enjoyed your publications of *Radio-Craft* for some years. Some of the articles which you have submitted for the edification of the radio Serviceman and technician have proved to be very interesting, and in cases where we have made use of your suggestions we have found them to be quite satisfactory.

On looking through the August 1938 issue, which is to hand, it is interesting to note your article on wiring schools for radio. In my capacity as Chief Engineer of the firm, I have had the "pleasure" of designing various types of combination radio, public address and gramophone installations and although these installations have not been very large I thought that perhaps you may be interested to know what has been going on along these lines in Australia. The en-

(Continued on page 319)

A COMBINATION DX

Various mechanical methods for turning a shortwave (Golden-Leutz Superhet.) Leutz accomplishes this result stations in one locality this system will become increas-

CHARLES R.

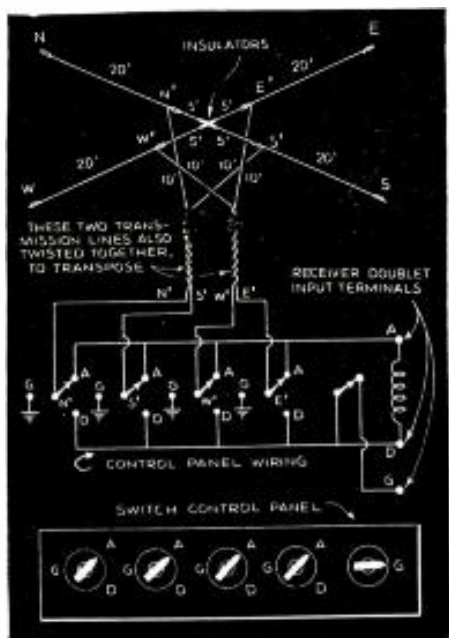
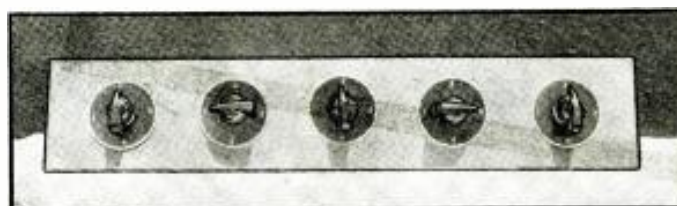

Fig. 1. Two shortwave aeriels crossed at right-angles and controlled at a remote panel constitute the Combination DX Directional Receiving Aerial.



Front view of the DX Antenna's remote control.

DX receiving fans are always looking for additional ways to bring in new distant stations. To obtain satisfactory reception from any one station, the strength of the received signal must exceed the local noise level, otherwise added receiver sensitivity contributes nothing toward the desired result.

Assuming the DX fan has a capable all-wave receiver, the receiving range, especially on signals ordinarily considered too far below the noise level to be amplified properly, can be greatly improved through the use of a directional aerial. This fact is of course generally known, but most directional aeriels in use are only effective in a few of all the possible directions which may be desired. This means that possibly some signals passing the aerial never reach the receiver input circuit.

directional antenna together with a switching arrangement permitting reception in each of several directions as required. Depending upon the length of the elevated wires and the angles between them, such an aerial will be most efficient at some certain frequency and most effective for some certain direction, that is for the case of a 2-wire V-doublet such as EE', S'S in Fig. 1. Such a doublet will also be satisfactorily efficient at all harmonics of this frequency and give fair response on other frequencies. This is especially true using doublets with a V lead-in to the start of the transmission line.

ANALYSIS

Figure 1 illustrates a special DX aerial, the directive qualities of which can be controlled at will by the receiving operator. As shown the aerial consists of 2 doublets at right-angles to each other. The V-type lead-in is used in order to cover the widest possible range of frequencies with the best possible efficiency. For experimental purposes, there is no reason why other types of lead-in cannot be tried, for example feeders as used with the Johnson "Q" method of construction. However for the DX receiving fan, the converging V lead-in to the start of the transmission line will probably be found best.

As shown in Fig. 1, each of the 4 elevated wires of the aerial has its own lead-in wire running direct to the control switch panel. The leads of the East and West wires are twisted together to transpose same. Likewise the leads of the North and South wires also are transposed. Then these 2 cables are twisted together, making a 4-wire lead-in cable with approximately equal impedances between any two of the wires.

The switch panel consists of 4 toggle switches, one for each lead-in wire. Each switch is a single-pole 3-way type having an "off", or "dead", center position. A 5th switch, single-pole and single-throw, is provided to connect one side of the doublet input to ground, D to G, when using any combination of ordinary aeriels. The 3rd position of the toggle switches allows grounding any unused elevated aerial wires, if desired. Under some circumstances one or more

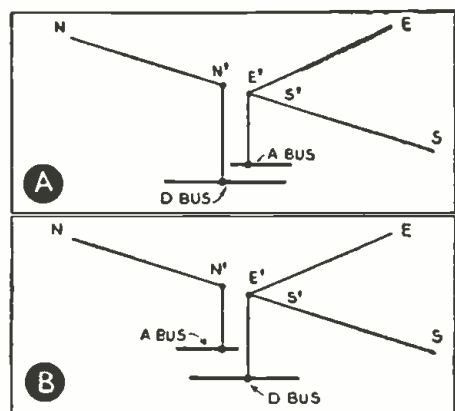

Fig. 2. Optional lead-in connections. Note that in the first case (A), wire W-W' (not shown) can float free or be grounded if desired.

DIRECTIONAL DX ANTENNA

Where space permits, a directional aerial of the type to be described by the writer can be erected that will be effective in a large number of different directions. Furthermore the particular direction desired is readily controlled—electrically and without any moving parts—by a simple switching arrangement.

In addition to extending the receiving range, this combination directional antenna system is equally useful in excluding interference simultaneously from other directions. The many advantages are instantly obvious upon examining the drawings pertaining to this article.

This flexible directive antenna system and switching control panel permits selecting a wide choice of doublet combinations. In most cases a combination can be connected which will be highly effective in the one desired direction and accordingly about 75% of all possible interference is automatically eliminated.

In commercial practice, a directional aerial is usually designed to be effective only in one direction and efficient for one narrow band. For other bands or directions, additional aeriels are used. This expensive construction also requires considerable space. Few amateurs can consider following the commercial practice. The best alternative is a combination

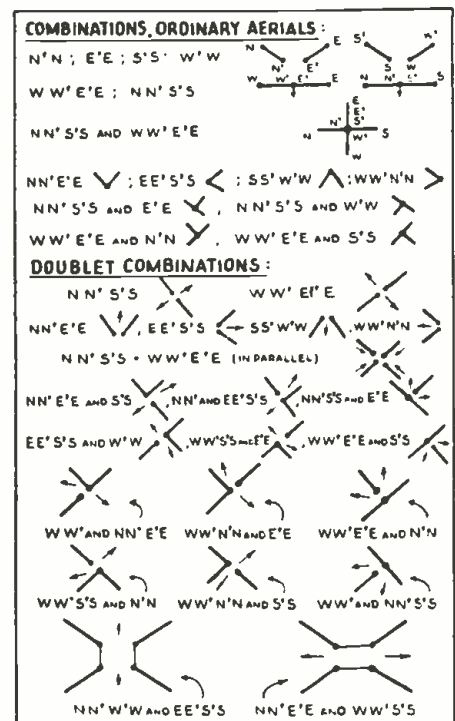

Fig. 3. Possible connections for the doublet.

DIRECTIONAL RECEIVING AERIAL

antenna for best results from a given direction are in use, but Mr. Charles simply and effectively by electrical means. With the advent of 2 or more television ingly useful to Servicemen. Some progressive manufacturer will soon snap this up.

LEUTZ

Interior of the DX Antenna's remote control unit. Note simplicity of wiring.

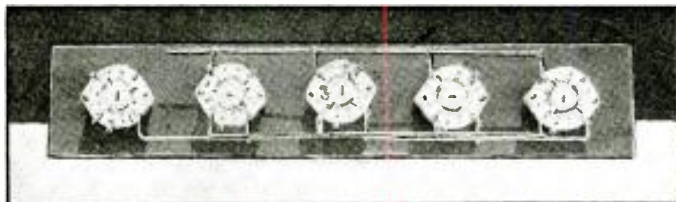

unused wires being grounded will add a useful reflector effect.

As the 4 elevated wires are 90 degrees apart using any one V connection, for example EE'S'S, theoretically the best results would be obtained by having the 2 wires $1\frac{1}{2}$ wavelengths in length. As most DX fans have limited space, some will have to use wires only 1 wavelength or even $\frac{1}{2}$ -wavelength in length, and such dimensions will give very satisfactory service. The aerial upon which this article is based had 4 wires each about 20' long, separated 10' at the center and each of the V leads to the transmission line being 10' long.

An interesting feature to note is that most combinations can be fed into the receiver doublet input circuit in either of 2 ways. For example in Fig. 2, the doublet consists of one leg NN' and the other leg EE'S'S. The approximate direction is NE by E. However there is a choice of connecting either the single leg or the double leg to "A" of the doublet input. In actual practice there is often a marked difference between these 2 arrangements.

With one side of the receiver doublet input coil grounded (switch D to G), and using the elevated wires as simple aeriels, there are 16 useful combinations. Any one of the 4 wires can be used alone, NN', EE', SS' or WW'. All 4 wires can be connected together for an "X" aerial. Any one of 4 "V" connections are available, for example NN'E'E. Either straightaway is available, WW'E'E or NN'S'S. Either straightaway can be connected to one leg, on either one side or the other, for example straightaway WW'E'E and leg S'S.

Using doublet connections there are at least 21 useful combinations, some of which are effective in more than one direction. Figure 3 shows these various arrangements.

TWIN DX ARRAYS

For the amateur who goes in for DX reception in a big way and has space available, a still more elaborate aerial can be erected. By referring to Fig. 4 the construction shown covers 2 arrays similar to the single one just described. This adds 4 decidedly directional V-doublets in a vertical plane, and any one

of these can be used singly or in a seemingly endless combination of vertical doublets, horizontal doublets, reflector wires and plain aerial wires. This more elaborate array requires an 8-wire transposed lead-in and a switch for each lead at the control panel as well as the doublet coil grounding switch.

For example the vertical doublet WW'w'w is highly directional as indicated by the arrow in the drawing. The horizontal doublet NN'W'W' provides maximum reception of signals arriving from the southeast (dotted arrow). With these 2 doublets in parallel, that is both connected to the doublet input circuit at the same time, the array is still effective to either of 2 directions (indicated by the arrows), and also directive to a 3rd direction, resulting from the effect of the combination of the 2 aeriels.

Often it is calculated that a certain desired signal should arrive from a definite direction. In actual practice, especially under unusual conditions, for example magnetic storms, signals may arrive in some direction entirely different than that anticipated. The flexible arrangement described gives the DX fan unlimited opportunities to secure unusual experimental results and to log many new distant stations.

TELEVISION

As television broadcasting activities expand, many new transmitters will start service. The television receiver owner will then be confronted with the problem of reception on several different frequencies and also from more than one direction.

Efficient reception from several television transmitters located in different directions from the receiver and each operating on a different frequency band presents a problem which can be solved by several methods. One solution would call for an aerial, adjustable in direction and also having adjustable characteristics to cover a very wide frequency range. An alternative solution consists of a separate aerial for each direction and frequency band involved together with a switching arrangement to change from one aerial to another as required.

For television reception, the receiver owner is more concerned, ordinarily, about receiving from 2 or 3 definite

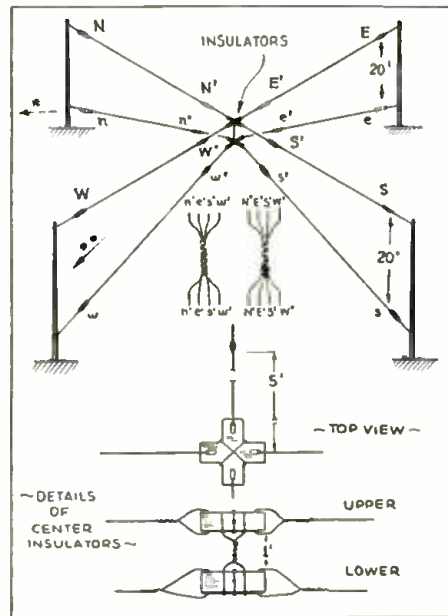

Fig. 4. These 4 directional V-doublets permit seemingly endless combinations. See Fig. 1 for details of "V" leads to transmission line. (*) Direction for horizontal doublet NN'W'W'; (**) direction for vertical doublet WW'w'w.

directions, rather than reception from all possible angles. Therefore 2 or 3 long "V" aeriels, pointed in the desired directions can be erected as required, together with a switching arrangement at the television receiver.

A long "V" erected for the above purpose should have legs each 4 wavelengths long, and the legs separated at an angle of 50 deg.

That is, with elevated wires NN', E'E and S'S, but each separated 50° instead of 90°, the system provides the 50° "V" NN'S'E, the 50° "V" EE'S'S and the 100° "V" NN'S'S.

Under some circumstances it may be desired to use this aerial system with the switching taken care of at the elevated end of the transmission line. In other words, only 1 efficient (coaxial) transmission line would be used and the connections between the elevated aerial elements and the line made by remote control.

The remote switching control can be mechanical, using either a rigid or flexible drive shaft, or can be accomplished with 4 relays, or with a multiple-step electromechanical rotary selector switch.

For high-frequency operation, the selection of low-loss insulation is most important. In the original antenna described above the elevated elements are supported by pyrex strain insulators $3\frac{1}{2}$ ins. long. The control switches are Centralab No. 2542, isolantite-insulated.

An Easily-Built STAGE ANALYSIS TESTER

The author describes a test instrument for applying the stage-by-stage method of servicing radio receivers while the sets are operating. If built exactly according to instructions a time-saving test instrument will result.

JAMES F. RINKE

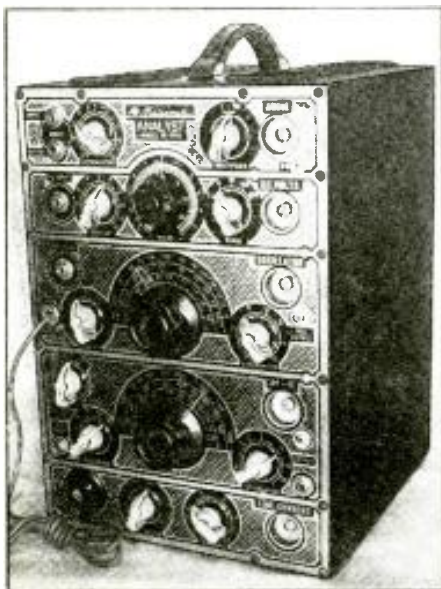

Front view of completed stage analyzer. Note column of "eye" tubes at right.

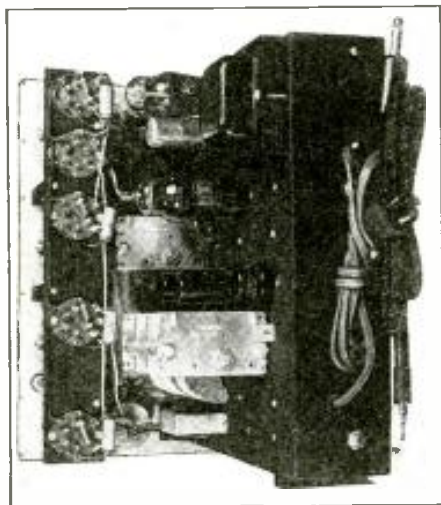

Rear view of the complete stage analyzer. Note column of sockets for "eye" tubes at left.

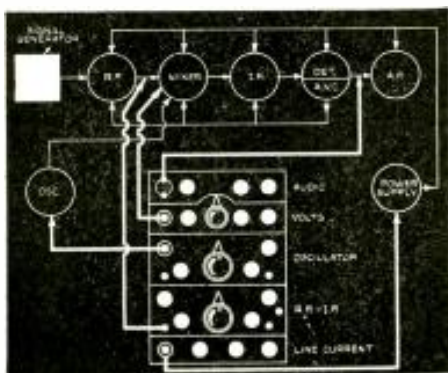

Fig. 2. Block diagram showing stage analysis tester as connected for checking a superhet.

If Mr. Average Serviceman were abruptly asked, "What is the most difficult and time-consuming job that you are called upon to perform?" he would probably, after some deep consideration, launch forth upon an exposition of some involved service procedure that would very likely not be met up with once in a blue moon.

As a matter of actual fact, the biggest problem with which any Serviceman is faced is simply the location of the point of trouble in the receiver he is to repair. If he gets what he calls an "easy job" it is merely because it didn't take him long to find the trouble—a blown filter condenser or defective rectifier tube. On the other hand, he will describe to you as a difficult job, one which, in the final analysis, was hard to lick only because it required such a long time to localize the defect, a couple of hours having been spent (for example) with ohmmeter and voltmeter before a final, exasperated session with the trimmers and padders luckily disclosed the fact that the oscillator had drifted off frequency.

It follows, therefore, that in order to make every service job an "easy" one, it is only necessary to provide some means of quickly locating the defective area in the receiver—a method of eliminating the painful hours of wasted time on the wrong track. A new service tool that proposes to do this very thing, and named the "Analyst," may now be constructed with a minimum amount of effort by using the complete kit as supplied by the manufacturer. It is recommended that the parts be obtained in this manner, providing a carefully engineered layout and a professional front panel, but inasmuch as many Servicemen will have their own ideas along these lines the complete circuit diagram is shown herewith in Fig. 1.

The fundamental principle of this novel instrument is the fact that it provides a simple means of tracing the received signal through the various circuits of the receiver, observing at any point the relative magnitude and quality of such signal, thus permitting the determination of the actual point in the circuit at which the signal disappears, becomes distorted or noisy, fades or exhibits some other undesirable trait. Once the trouble has been located a few simple resistance measurements or a minor trimmer adjustment will serve to "put the finger" on the actual defective part. The time consumed in making these tests will be measured in minutes in-

stead of hours, and any progressive Serviceman will tell you that time means money, now more than ever before.

PANELS OF THE ANALYST

It will be seen that the instrument is divided into 5 distinct channels, each of which may be connected independently to a separate portion of the receiver under test and whose controls are conveniently arranged on separated portions of the front panel to simulate the familiar "rack-and-panel" type of construction. This feature alone eliminates a lot of guess-work in testing as it is apparent at a glance, just which portion of the instrument is in use and exactly which controls are associated with that particular test. Thus, by a few simple connections to the receiver, the entire circuit may be considered to be transferred to the panel of the test instrument for analysis and observation!

The same separation of controls and functions that is apparent on the front panel of the instrument is also readily observed upon further examination of the main circuit diagram. Each portion of the circuit will be seen to be entirely independent of the other with the exception of the common power supply.

In order to provide a more comprehensive picture of the inner workings and operating capabilities of this versatile instrument a brief discussion of each channel will be given in the order in which they appear on the front panel. It will be understood that such a discussion will not be able to even mention all of the possible tests which an instrument of this type is able to perform, but the major features will be given together with some of the more important service procedures, from which an almost unlimited number of ramifications will be evident to the reader who will pause to consider the implied possibilities.

Audio Channel. Looking at the circuit of the *Audio channel*, it will be evident that it is simply a single-stage audio amplifier with a diode voltmeter (both functions being combined in the 6SQ7 tube) and an electronic indicator tube. A suitable calibrated Multiplier and Attenuator permits voltage measurements at audio frequencies to be made within a range of 0.1- to 1,000 volts. The frequency characteristic is essentially flat throughout the entire audible range. Signal input is introduced into the channel through a shielded cable which plugs

CONDENSERS—*Minus Guesswork*

The author describes the newest-type condenser tester which checks all types of condensers for capacity, opens and shorts, power factor and for intermittents. Capacity range, 10 mmf. to 50 mf. A Wien bridge circuit and "eye" indicators are used.

WILLIAM ROBINSON

MORE and more the Serviceman feels the need for speed and convenience in his test units, and for certainty in every step of his work. The day is long past when he could afford to depend on guesswork or blind substitution in locating and correcting defects in a receiver being serviced. As a result an ever increasing variety of dependable test and measurement equipment is being designed and produced to aid him in his work.

Some of this equipment because of its effectiveness, compactness and simplicity would have been the envy of the large engineering laboratories of a few years ago! It was not unusual in those days (and we are not thinking back so many years, either) for skilled laboratory engineers to devote much of their time to developing and setting up test and measuring equipment. Today, except in the most unusual cases, such equipment is available on the open market in a form—and at a price—which makes it practical for the smallest service shop to boast some equipment found in few laboratories of years gone by.

BRIDGES—OLD AND NEW

Take, for instance, equipment for checking condensers and measuring their capacity. A "bridge" set-up for this purpose often costs hundreds of dollars in capacity and resistance standards, audio-frequency source, balance indicating devices, etc.; and oftentimes infinite patience and time in providing proper shielding. Many is the capacity bridge of this type that proved to be a "one-man" job because the operator had to stand in a certain critical position when using it, otherwise his body would make its contribution to the capacity under measurement.

Contrast such as this with a *new* bridge that has just been placed on the market—a little instrument small enough to be slipped in a coat pocket and yet, without external accessories of any kind, capable of measuring capacities from 10 micromicrofarads to 50 mi-

crofarads, checking for opens and shorts, indicating power factor, checking circuit continuity, and doing all this with only two controls, one of which is a calibrated dial which provides readings directly in capacity.

The development of this tiny bridge was, of course, not accomplished overnight. Realizing the wide utility of a device which would enable the Serviceman to measure any type condenser, either a new one or one in a receiver circuit, the problem was to develop such an instrument and make it so utterly simple to operate that it would give instant direct-reading measurements, could be used anywhere at any time without external attachments (other than to plug it into the A.C. power line), and would be in a price class which would make it entirely practical for even the radio experimenter and the smallest service shop.

SPECS.

The result is the Condenser Bridge here illustrated. It employs a true bridge circuit (Wein) recognized universally for its practical effectiveness and accuracy. The housing is a moulded bakelite case only 5 ins. long, 3 ins. high and 3 1/2 ins. wide. Inclosed in this are the standard condensers and resistors which make up the bridge arms, a 12A7 tube which serves as amplifier and rectifier, a transformer, a 6AF6-G tube as balance indicator, and range as well as power switches.

The use of the 6AF6-G tube to provide sharp visual indication of the balance adjustment is a distinctly advantageous feature as it not only is more precise than the older audible method of balance but also permits much more speedy operation. This tube is one of the newer types of tuning "eyes" and indicates balance in the maximum-"open" position of the eye.

The range selector switch has 3 positions, providing ranges of .00001-.002, .001-2 and .1-50 mf. The concentric capacity calibrations for those 3 ranges



Photograph of the Cornell-Dubilier model BN Condenser Bridge.

are embossed on the top panel of the instrument with the pointer-type balancing knob rotating over these scales. Tip-jacks for the test leads are also mounted on the top panel, and the off-on switch on one side of the case.

TEST PROCEDURE

Capacity.—In checking a condenser it is connected by test leads to the pin-jacks on the instrument (or plugged into the tip-jacks directly by means of its own pigtailed). The Range Selector Switch is then set for the proper range and the balancing knob rotated until the "eye" shows the maximum opening. The capacity reading is then made from the scale corresponding to the range for which the switch was set—and that's all there is to it! The whole job takes a matter of seconds.

Opens—Shorts.—The two extremes of the balancing scale are marked OPEN and SHORT, and wherever either of these conditions is encountered in a condenser under test it will be indicated by the fact that the balance point is attained with the knob in one of these positions. With the knob in the SHORT position the bridge also serves as a regular continuity tester as any circuit of less than 500,000 ohms will show an indication on the meter whereas an open-circuit will not.

Power Factor.—Measurements of capacity values and tests for short and open conditions represent the most common applications of this bridge. But there are also other condenser charac-

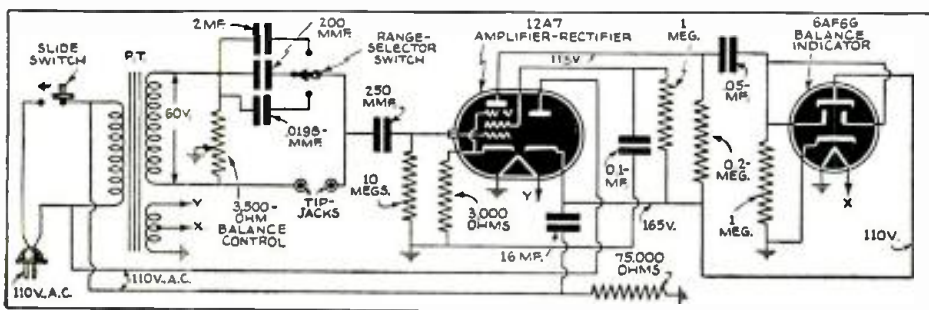

The new condenser tester employs a true bridge circuit of the Wien type which is effective and accurate.

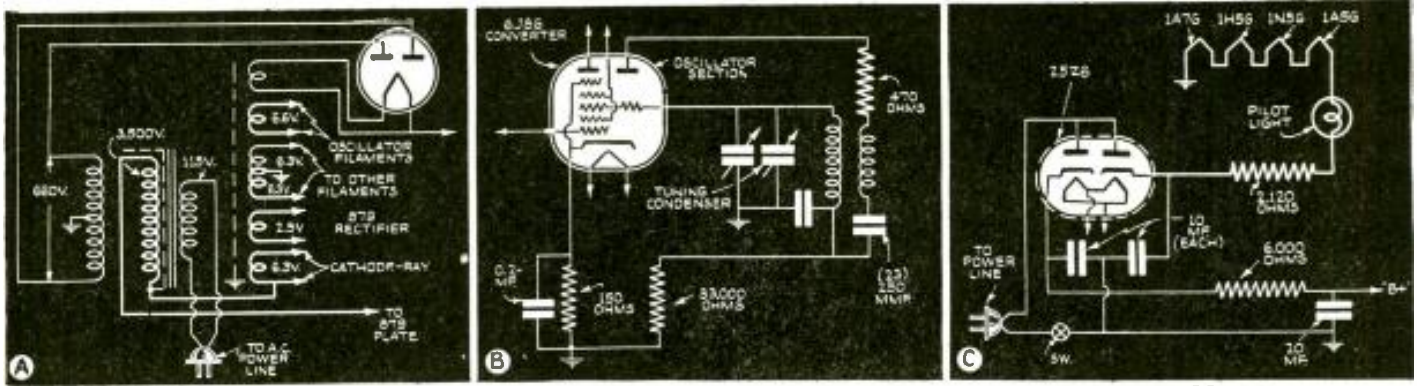

Fig. 1. New circuit features of (A) RCA Telly Sets TRK-5, TT-5; (B) Philco Model 40-165; (C) Automatic Radio Models P-57, P-58.

NEW CIRCUITS IN MODERN RADIO RECEIVERS



The details of the modern radio receiver circuits that make them "different" from previous designs are illustrated and described each month by a well-known technician.

F. L. SPRAYBERRY NUMBER 26

(1) TELEVISION RECEIVER USES SINGLE POWER TRANSFORMER

RCA models TRK-5 and TT-5. One power transformer supplies all filaments for the video and sound sections of the receiver, the rectifiers and cathode-ray tubes, the medium-high voltage for the amplifier's plate and screen-grid supply and the high voltage for the cathode-ray tube.

As in Fig. 1A, the high-voltage winding of approximately 3,500 volts is completely shielded. There is an individual filament winding for the main input high-frequency oscillator and additional filament windings for the cathode-ray tube, and the high-voltage rectifier filament.

Insulation and shielding is naturally of a superior quality than would be necessary for the usual power transformer.

(2) IMPROVED OSCILLATOR OUTPUT AND FREQUENCY STABILITY

Philco model 40-165. For a minimum of switching accessories or circuit changes for band changing, good oscillator frequency stability and output is obtained by a modified oscillator circuit.

In Fig. 1B, the circuit shows a small resistance (470 ohms) between the oscillator plate and the plate coupling coil. The plate and grid circuits are coupled in part, and at the same time isolated with respect to their D.C. values, by means of condenser 23 (250 muf.). While the reactance of the condenser alone, will change almost 35 times in the total tuning range, with the resistor the impedance will scarcely change 75% in the entire frequency band. The possibility of oscillation stopping due to tuning to resonance with the plate coil and this coupling condenser is eliminated and insofar as the plate load is made more constant the frequency is stabilized. A very practical circuit for wide-range tuning with a simplified switching system is thus realized.

(3) RECTIFIED FILAMENT SUPPLY IN BATTERY-UNIVERSAL PORTABLE

Automatic Radio Manufacturing Co. models P-57 and P-58. During A.C. or D.C. line operation, one set of rectifier elements supplies the filament circuit so that 1.4-volt tubes may be used with their requirements of D.C. filament supply.

In order that these sets may be efficient, lightweight portables for battery operation, 1.4-volt tubes are used. When an A.C. or D.C. line is available, however, the batteries may be reserved as all power may be obtained from an A.C. or D.C. line as in Fig. 1C. One of the rectifier sections in the 25Z6 tube is used to supply the complete filament circuit and a pilot light through the proper voltage dropping resistor. Completely adequate plate and screen-grid supply may be obtained from the other rectifier elements (one plate and its associated cathode).

(4) DETECTOR FOR FREQUENCY-MODULATED SIGNALS

General Electric model GM-125. Modified use of the conventional discriminator circuit in this receiver serves as the detector system of the receiver of frequency-modulated signals.

The detector, Fig. 2A, is preceded by a "limiter" stage to keep the detector input at a constant signal level. Low plate and screen-grid voltage, no bias, and A.V.C. produced by the 6SJ7 tube produce a substantially constant carrier
(Continued on page 315)

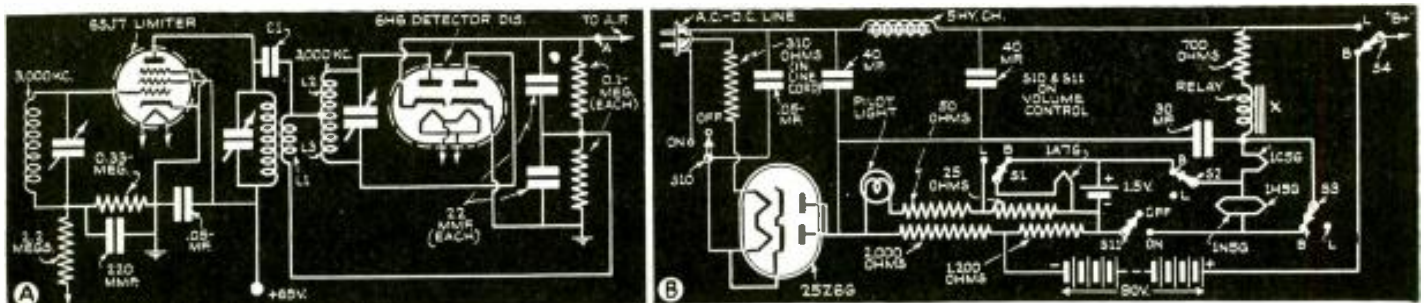

Fig. 2. New circuit features of (A) General Electric Model GM-125; (B) Pilot Models T-1452, H-1451.

"PORTABLE SOUND"

ADVERTISERS are recognizing to a greater extent than ever before the advantages of Public Address advertising. However, a P.A. business must not only be run on a business-like basis, but must be technically and psychologically as near perfect as possible. The following hints regarding more advantageous use of sound equipment is directed mainly toward owners and operators of portable apparatus (sound trucks, and the like).

Most Sound operators realize that the day of haywire setups is past. Any parts subject to wear or vibration should be protected and only the best of parts with adequate safety factors should be used. Failures of equipment almost always occur at the critical moment.

For the maximum results your message should be brief and to the point. A long message defeats itself because many people lose interest before your point is made. In general, a 50-word message with special emphasis on only 2 or 3 words will be understood and remembered. A short message has the further advantage of permitting you to move with greater speed through traffic.

SOUND-SYSTEM INTELLIGIBILITY

The sound operator can, in many cases, cooperate with advertising agencies and sign companies; this results in mutual benefit. The idea of a series of talking, moving billboards is not so far-fetched. Visual repetition of the sound serves to fix the announcement much more firmly in the minds of the observers. If the frequency response of the sound system is very poor (as in many I have heard) by all means have a large sign so that those who are disturbed can discover what it is you are talking about.

The frequency response of a sound system is extremely important. A clear whisper can be more easily understood than a thunder of muffled speech. Speech is usually the important thing in a portable sound system; therefore, do not neglect the high-frequency response. Background noise which is at all noticeable, is usually objectionable to the advertiser—even though someone might tell him that there was no charge for it.

A clear, undistorted voice, carrying all the original overtones will be understood above most city noises. It is necessary to compel the attention of those on the streets, therefore let the announcer use a commanding tone in his voice. Each word should be enunciated clearly. One cannot over-emphasize the importance of a good announcer using a compact, to-the-point speech. The announcer should, if possible, attend a public-speaking class and also follow the lead of some of the better radio announcers.

The distance of the announcer from the microphone should at least be a few inches or enough to prevent either the formation of a cavity which would alter the frequency characteristic of the microphone, or any tendency to increase acoustic feedback. If it becomes necessary to hold the microphone closer, it should be held with its edge toward the announcer in such a position that the sound which is emitted from the nose will also be picked up; otherwise the announcer will sound as if he has a cold in the head. (If held close and full-on instead of edgewise there is danger that objectionable "halimicrosis"—to coin a word—or "microphone breath" sounds, as the expelled breath is impelled against the diaphragm, will be picked up.—*Editor*)

The use of music should be restricted to small towns where the inhabitants will listen to it because of the novelty of hearing a sound system. In large cities, an attention compeller such as an unusual whistle or noise is good to force the attention of those who otherwise would not listen. If the noise can be tied-in with the thing being advertised, so much the better; for example, an imitation of a cow or horse or rooster for a stock show; a train whistle for a welcome to be held at a railway station; a horse neigh for a rodeo. Such sounds are so unusual in a city street that they force the attention of all who hear.

CHOICE OF EQUIPMENT

There is a wide range in choice of equipment. Cone-type dynamic speakers have better bass response than the small exponential horns used
(Continued on page 307)

Trouble with . . .

. . . MAJESTIC 460, 490

These sets often "play" very weakly on a station, and this is accompanied by a loud noise very much resembling a bunch of "firecrackers" going off. This trouble I isolated in the first I.F. transformer. After replacing with a standard transformer everything seemed all OK. That is, all right for an hour or so, then a similar noise appeared—not so loud, but very annoying. This time trouble in the other I.F. trans. As this is not a standard size, or construction, a duplicate must be used. (There are 3 windings in this transformer, as shown in Fig. 3.)

It is well to remember, that in these sets it is always advisable to replace both I.F. transformers as they all "crack up" at about the same time, and a single replacement will only bring grief and call-backs.

. . . RCA-VICTOR 262, 263

The volume control in Models 262, 263 has been a frequent source of complaint. Reception may cut off completely or to a very low level, with wavering or broken response upon the slightest vibration. Manipulation of the control should readily disclose the cause for the trouble, although in some instances, the solution is more baffling. Noisy reception upon vibration is due also to the volume control. Replacement is not always necessary, since the control may be dismantled and cleaned. Removal at first glance appears difficult because of close quarters, but is easily accomplished by removing the volume control assembly which includes the bracket that supports it. The threaded stud fastened to the bracket

passes up through the chassis in a rubber grommet, and is held in position by the customary nut and lock-washer.

A volume control that is found noisy even after repair or replacement is the result of contact resistance. A smooth and noiseless repair may be effected by isolating the volume control from the diode load circuit with a 0.05-mf. condenser and a 0.25-meg. carbon resistor (see factory diagram). All that need be done to accomplish this change is to unsolder the green lead connected to the bottom lug of the control from the lug on the terminal strip adjacent to the control, and to solder this lead to the unused lug at the end of the strip. The 0.05-mf. condenser is connected across these two lugs with the 0.25-meg. resistor connected from the first lug to chassis.

. . . SETS USING 6A7 TUBE

Go dead intermittently. Careful tube tests reveal no shorts or leaks, but persistent tapping of the 6A7 tube, in the set, finally duplicates the trouble. Replace the tube.

. . . CAN. WESTINGHOUSE 175

The complaint here is great distortion at medium volume levels, seemingly worse on speech than on music. The analysis reveals low plate voltage and zero current on the 6F5. Replace the leaky 0.25-mf., 6F5 plate bypass condenser.

. . . SPARTON MODEL 589

No reception is frequently caused by an open primary on the push-pull input transformer.

(Continued on page 315)

SERVICING

Questions & Answers

CROSLY SET DOESN'T TRACK

(138) J. R. Bogess, Greenville, Ky.

(Q.) A Crosley model 178 battery receiver has been causing trouble. I have replaced the speaker, the volume control and oscillator coil. Stations are received at only one end of the dial—700 to 550 kc. When I switch the oscillator coil leads, primary and secondary, stations come in at the other end of the dial, 1,100 to 1,500 kc. For example, WLW comes in very well at 1,200 kc. but weakly at 700 kc. What could possibly cause this?

(A.) From the facts stated, only one possible answer may be given with regard to the trouble being experienced with your Crosley "Fiver". The wrong coil has been employed to replace the oscillator coil. Suggest that a new coil, which has been definitely established as an oscillator coil for the model 178, be installed.

CAR-RADIO SET INOPERATIVE

(139) T. Wojciekowski, Brooklyn, N. Y.

(Q.) A Philco auto-radio set, chassis 1450, code 121, was received in an inoperative condition. Reception can be obtained only when the plate prong of the 78 I.F. tube is touched with a test

lead. When the 32,000-ohm resistor in the screen grid circuit of the 6A7 was shunted temporarily, the set "played" and has operated since. The receiver has developed a good deal of inter-station noise. Can you tell me what is wrong?

(A.) The condition described in your letter, wherein an inoperative Philco auto-radio set was made to function by placing a test lead upon the plate of the I.F. 78 tube, may have been due to oscillation in the I.F. stage, caused by an open screen-grid bypass condenser. The additional circumstance of recovery when the screen-grid series resistor of the 6A7 was momentarily shunted, points toward this. Replace the screen-grid bypass condenser.

VOLUME LOW

(140) William G. Newman, Detroit, Mich.

(Q.) I have an RCA Radiola 33 which operated nicely until a few weeks ago, when it suddenly went down in volume. The tubes have all been replaced, and I can't find any open anywhere. There is one local station that I can get, but it's very weak, even with the volume control at its maximum point. The reception from this one station seems to be quite noisy. What is the trouble?

(Continued on page 312)

USEFUL KINKS AND CIRCUITS

Contributions to this new department are paid-for at space rates; what previously-unpublished ideas to help fellow Servicemen, experimenters, etc., do you want to submit? A short description and pencil sketch will do.

MAKING MILLIAMMETER MULTIPLIERS

by Serviceman E. H. Thompson

PAY as high as \$2 for a multiplier resistor—if you can afford it! But if you can't then with a little work and time you can make your own for practically nothing. Also the shunt resistors you buy do not apply to all milliammeters.

Get the meter you want to multiply. For example, we will use a 10-ma. (milliampere) meter. We want to extend the range to 100 ma. Obtain a small drycell (flashlight type will do) and hook it up to the meter in series with a variable resistor as shown.

Be sure this is connected correctly, as otherwise you will burn out the moving coil of the meter. The resistor must be large enough to reduce the voltage to the amount needed to give full-scale deflection on the meter. This value depends on the meter. However the resistance of a 10-ma. meter is around 8 ohms. Therefore by Ohm's Law a voltage of 0.08-volt is needed for full-scale deflection; $E = RI$, where $E = 8$ (ohms) \times 0.01-(ampere) = 0.08-(volts). To drop 1.5 V. (voltage of the drycell) to 0.08-V. a drop of 1.42 is needed. The current through a resistor, R, to produce this voltage drop will be 0.01-amp. (10 ma.).

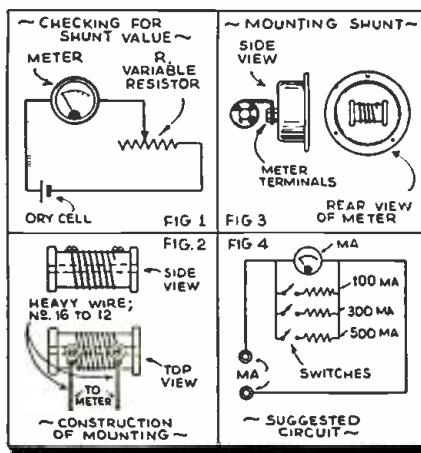

Using Ohm's Law again, $R = E \div I$, where $R = 1.42$ (volts) \div 0.01-(amp.); therefore R equals 142 (ohms). A value of 142 ohms is needed to dissipate the voltage drop. A variable resistor (rheostat) of 0 to 200 ohms will suffice. This must be variable. If you have no way of knowing the resistance of your meter use a larger-resistance rheostat until you find the approximate needed resistance, then use a rheostat having this lower resistance (max.) for the finer adjustment.

Now—set this rheostat for full-scale deflection on the meter (10 ma.). To extend 10 ma. to 100 ma., 10 ma. would be 1/10th of 100 ma.; and 1/10th of 10 ma. equals 1 ma., the needed reading. Get some fine wire, No. 28 to 32 D.C.C. (insulated). The finer the wire the shorter will be the length of the shunt wire, but also the more critical will be the cutting. Any size of wire can be used.
(Continued on page 305)

BASS TONE CONTROL

● HERE is an "add on" tone control or tuned band-pass filter for increasing the low-frequency response below 100 cycles in a radio receiver. Switch

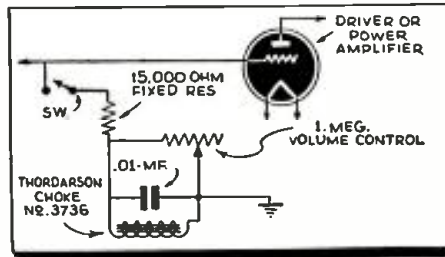

Sw. is necessary for disconnecting the tone control when receiving weak signals.

LOUIS L. STRANGE,
Miami, Florida

A 6H6 DETECTOR-"AMPLIFIER" CIRCUIT

● INSTEAD of functioning inversely, the 6H6 (diode-tube) detector-amplifier circuit shown here functions similarly to a triode, except that it has greater sensitivity and more "amplification."

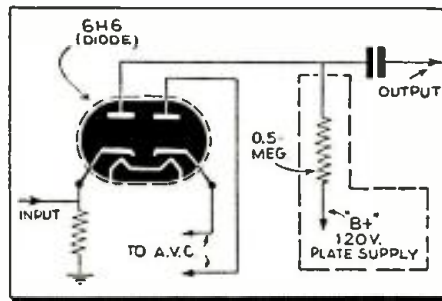

The cathode is connected to the input, and the plate is connected to the output. A 1/2-meg. resistor supplies the necessary voltage required for "amplification" and detection. This circuit has been used when servicing both regenerative and superhet. sets. When used in regenerative receivers the 6H6 tube can be used as a combined detector, "amplifier," and power rectifier.

ALBERT E. MOULIN, JR.,
PAUL ORCHARD, II,
New Orleans, Louisiana

NOVEL "ELECTRIC EYE" CIRCUIT

● HERE may be something of interest for the readers of *Radio-Craft* who wish to try something different, or Servicemen may wish to apply this circuit as an attention-getter. All that is needed is a radio set flashlight bulb, photoelectric cell, and a fairly-high-gain amplifier. Following is the diagram and its arrangement. See following note (*).
(Continued on page 309)

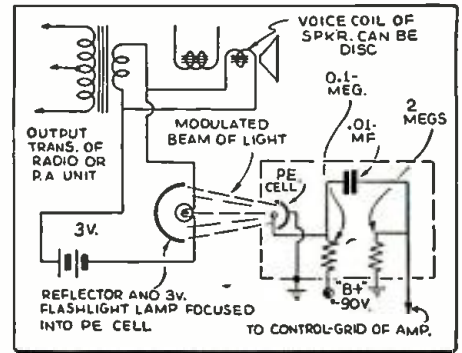

Other PE. cell diagrams can be found in past issues of *Radio-Craft* or in a PE. cell manual. The diagram above is the one I have used to feed into a 4-stage amplifier, employing 1-57, 2-56's and 2-45's P.-P., made up from parts I had laying around. It works out good, and is quite a novelty to have around. The 90 volts of "B" can be tapped from a power supply with a resistor to drop the voltage, and having an 8-16 mf. condenser for filtering.

JOS. KNOTCK,
Racine, Wis.

* Also see "The Skin-Effect Talking Light beam," *Radio-Craft*, Jan. 1939.

A SIMPLE PORTABLE AERIAL

● A SIMPLE aerial—ground unit for a portable set can be constructed as follows:—

A cheap 6 ft. steel rule of the concave-convex cup type is obtained, and the rivet passing through the center drilled-out and replaced by an old type terminal. This in turn is passed through a hole drilled in a piece of bakelite about 4 ins. long and 2 ins. wide.

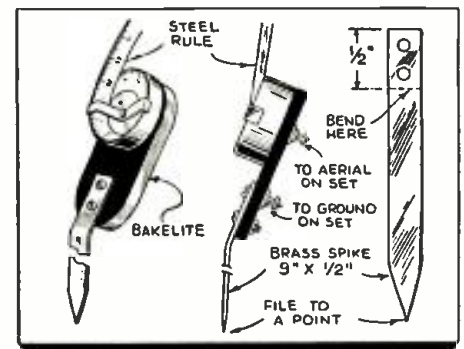

Now take a strip of brass 9 ins. long and 1/2-in. wide. This is bent and bolted to the bakelite as shown in the sketch. A terminal is also provided. In use, the pointed end of the brass strip is pushed into the ground, which should be dampened if it is dry, and the rule extended. The aerial and ground leads are taken
(Continued on page 309)

SERVICING "Coin-Operated" PHONOGRAPHS

Servicemen will find that, on 9 out of 10 calls, it's the sound system and not the mechanical system of coin-operated electric phonographs which requires servicing. There's business here for you.

SANFORD MILLER

No. 6

This month we devote our entire page to service diagrams of one of the more popular coin-operated phonograph machines—the Wurlitzer model 24. This machine, because it is several years old and widely distributed is the one most likely to require servicing at this time. The radio Serviceman should therefore be able to identify it on sight and be familiar enough with its amplifier circuit to be able to render prompt and efficient service if called. Indeed, the more aggressive Serviceman may even solicit such busi-

ness from local distributors and independent operators on the basis of his familiarity with the machine.

Similar service diagrams of other models will be published every other month so that in a given year the interested reader will have service data on all machines which have enjoyed wide distribution and therefore likely to require occasional servicing. And remember, you already have all the test instruments necessary to service these machines.

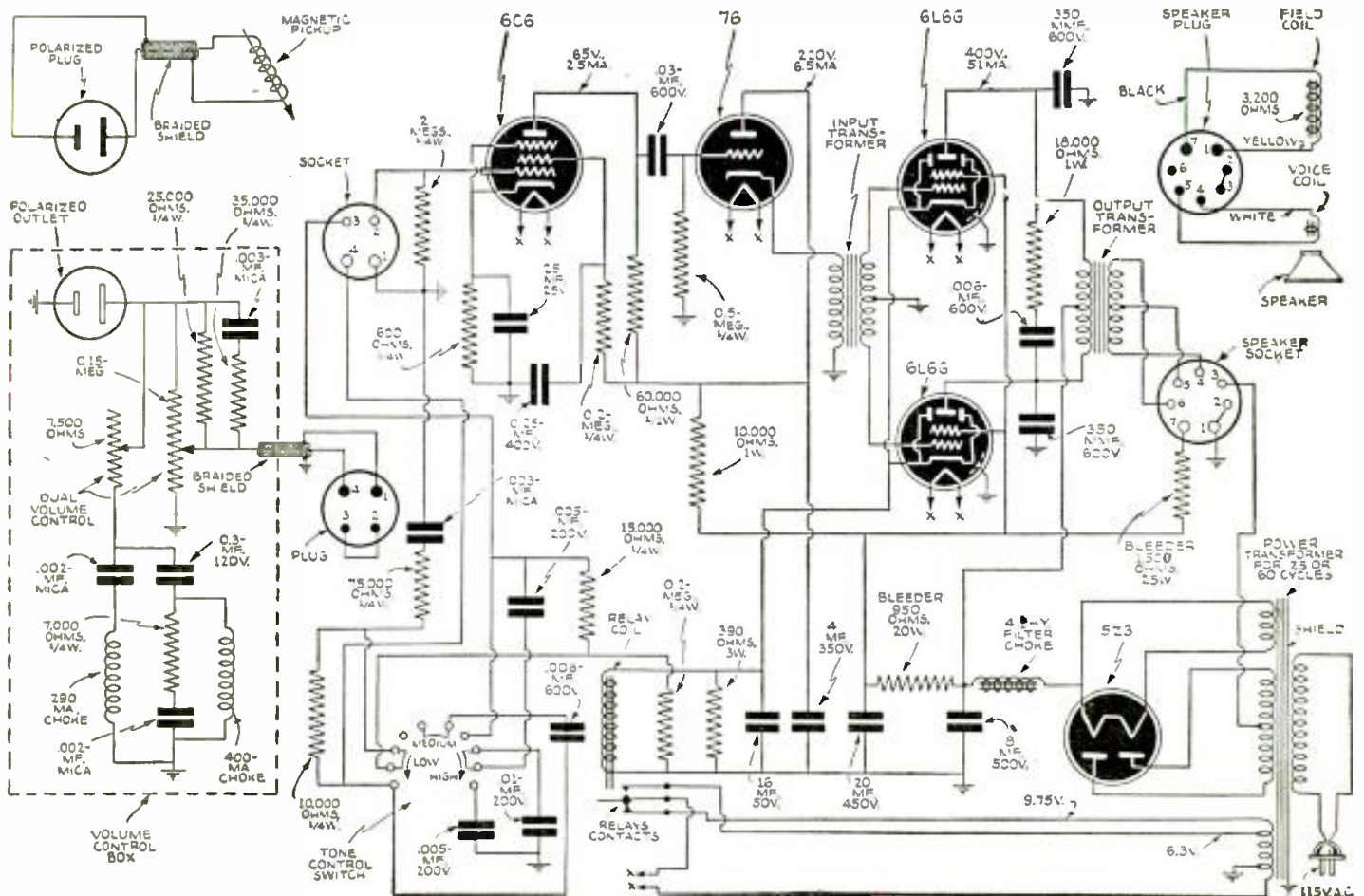

Complete schematic diagram of the Wurlitzer model 24 (and 24A) coin-operated phonograph. The amplifier itself is known as number 851. All essential voltage and current ratings are included.

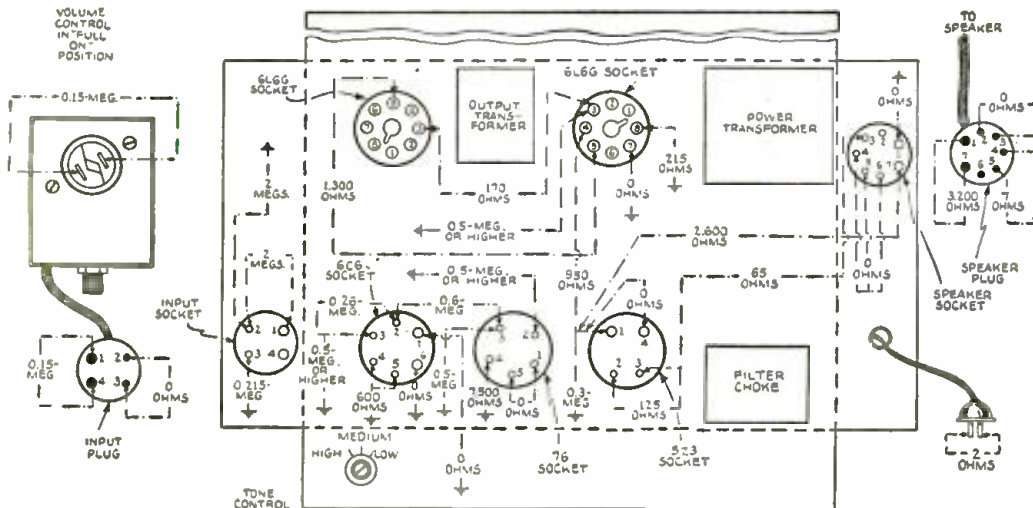

Pictorial diagram of the amplifier (No. 851) showing all point-to-point resistance values as well as the locations of the various components. Each value as specified should be within + or - 20%. Connect negative terminal of resistance meter to ground (chassis).



This is how the Wurlitzer model 24 looks. You've probably seen it more than once in various locations.

SONORA MODEL TW-49

5-Tube Superhet.; A.C.-D.C. Operation; Automatic Tuning; Automatic Volume Control; Tuning Range: 535 kc. to 1,720 kc. (includes 1,712 kc. Police Band); Provision for Television or Phonograph Connection.

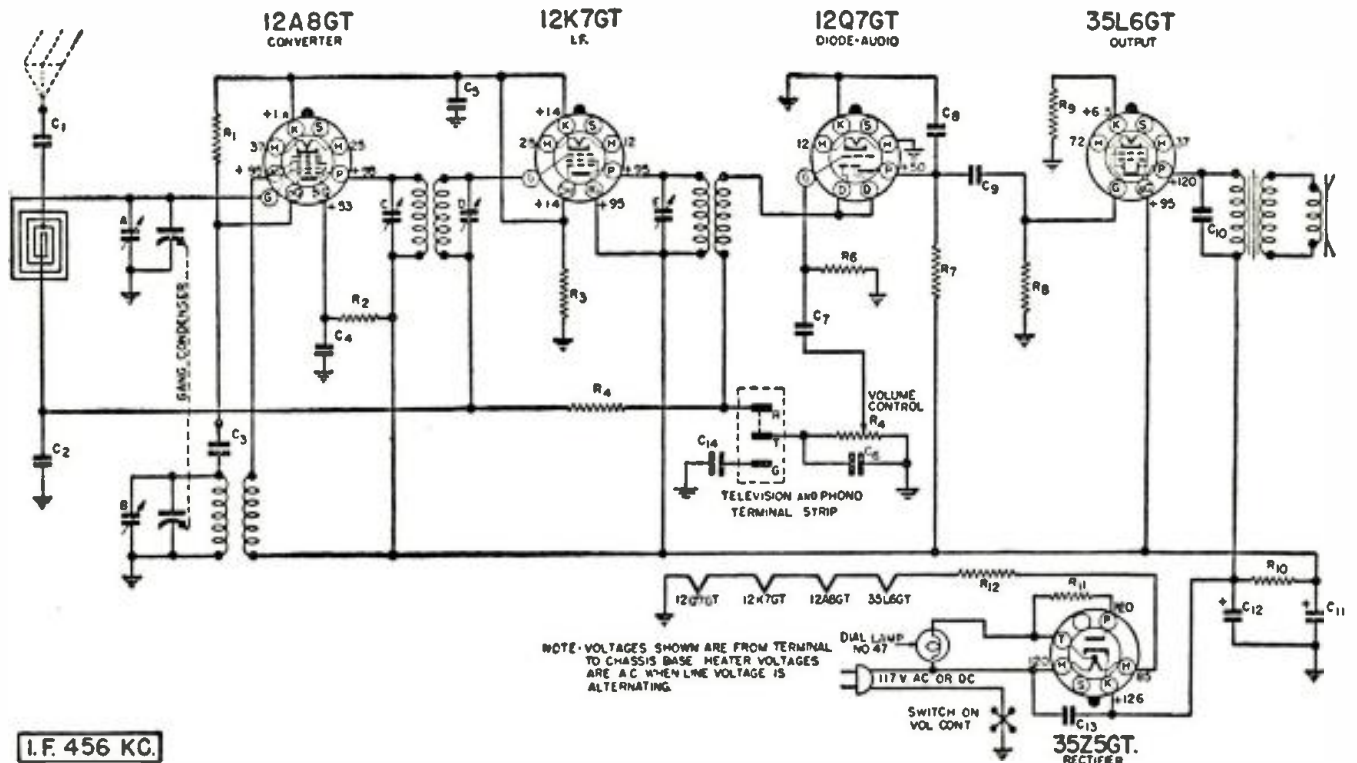

I.F. 456 KC.

Schematic diagram of the Sonora model TW-49. Voltages shown are measured with 1,000 ohms/volt meter.

- | | | |
|------------------------|------------------------|----------------------|
| RESISTORS | R10—2,500 ohms, 1/2-W. | C5—0.1-mf. |
| R1—50,000 ohms, 1/2-W. | R11—50 ohms, 1/2-W. | C6—100 mf. |
| R2—20,000 ohms, 1/2-W. | R12—80 ohms, 2 W. | C7—0.01-mf., 400 V. |
| R3—25 ohms, 1/2-W. | | C8—500 mf., 400 V. |
| R4—1 meg., 1/2-W. | CONDENSERS | C9—0.01-mf., 400 V. |
| R5—0.5-meg. | C1—0.01-mf., 400 V. | C10—0.02-mf., 400 V. |
| R6—10 megs., 1/2-W. | C2—0.05-mf., 200 V. | C11—20 mf., 150 V. |
| R7—0.2-meg., 1/2-W. | C3—50 mf. | C12—35 mf., 150 V. |
| R8—0.5-meg., 1/2-W. | C4—0.05-mf., 200 V. | C13—0.05-mf., 400 V. |
| R9—250 ohms, 1/2-W. | | C14—0.01-mf., 400 V. |

Lack of sensitivity and poor tone quality may be due to any one or a combination of causes such as weak or defective tubes or speaker, open or grounded bias resistor, bypass condenser, etc. Never attempt to tighten set until all other possible sources of trouble have been first thoroughly investigated and definitely proved not to be the cause.

ment of coils. Voltages shown on the circuit diagram are from socket terminals to chassis base. In measuring voltages use a voltmeter having a resistance of at least 1,000 ohms/volt. Allowances should be made for variations in line voltage.

ADJUSTMENT OF AUTOMATIC TUNING ADJUSTMENT. All adjustments are simply made from the front of the cabinet using an ordinary screwdriver.

To make adjustments remove all 4 buttons which pull off readily. The center buttons should be removed first since by depressing the adjacent buttons with thumb and finger a firm grip may be secured on either center button. The side buttons can then be easily removed.

Loosen the screw of the desired button and with the manual tuning knob tune to any desired station. Hold the accurate adjustment, the volume control should be set at a moderate level and the station tuned-in slowly to a point of maximum volume and clarity.

It is not necessary to follow any particular sequence of stations since each button is adjustable to any station.

OPERATION. With the set turned on to a moderate level of volume, the automatic tuner is operated merely by pressing a button set to the desired station. Station selection may be made automatically or manually at will since the manual tuning control operates free and independent of the automatic unit.

The station call letter tabs furnished should be inserted into the slot at the top of the pushbuttons using designations corresponding to the station selected for each button. After inserting call letter tabs the buttons may be replaced.

TELEVISION AND PHONOGRAPH CONNECTOR

This receiver is fully designed to provide sound reception when connected to a television receiver. To make this connection remove the connecting link from terminals "R" and "T" and attach the 2 leads from your television receiver to terminals "T" and "G". The black lead or the outside shield (in case a shielded lead is used) should be connected to terminal "G", and the other to terminal "T".

To use this attachment with a phonograph, remove the connecting link between terminals "R" and "T". Connect the two terminals from the phonograph pickup to terminals "T" and "G". If one of the pickup leads is a shield connect it to the terminal "G". If both leads are unshielded, try reversing the terminals if the hum is excessive. If hum is still present reverse the power plug in the wall socket.

NOTE: IT IS ABSOLUTELY NECESSARY THAT AN ACCURATELY CALIBRATED TEST OSCILLATOR WITH SOME TYPE OF OUTPUT MEASURING DEVICE BE USED WHEN ALIGNING THE RECEIVER AND THAT THE PROCEDURE BE CAREFULLY FOLLOWED, OTHERWISE THE RECEIVER WILL BE INSENSITIVE AND THE DIAL CALIBRATION WILL BE INCORRECT. THE TRIMMERS WILL BE REFERRED TO BY THEIR FUNCTION AS INDICATED ON THE PARTS DIAGRAM.

ALIGNMENT PROCEDURE

CORRECT ALIGNMENT PROCEDURE. The intermediate frequency (I.F.) stages should be aligned properly as the first step. After the I.F. transformers have been properly adjusted and peaked, the broadcast band should be adjusted.

I.F. ALIGNMENT. With the gang condenser set at minimum, adjust the test oscillator to 456 kc. and connect the output to the grid of the 1st-detector tube (12A8GT) through a 0.05- or 0.1-mf. condenser. The ground on the test oscillator should be connected to the chassis ground. Align all 3 I.F. trimmers to peak or maximum reading on the output meter.

BROADCAST BAND ALIGNMENT. Remove chassis from cabinet and set it up on the test bench taking care to have no iron or other metal near the loop. Do not make this set-up on a metal bench.

Connect the test oscillator to the antenna of the set through a 200 mf. (0.0002-mf.) condenser. With the gang condenser set at minimum capacity, set the test oscillator at 1,720 kc., and adjust the oscillator for 1,720 kc. (trimmer) on gang condenser.

Next—set the test oscillator at 1,100 kc., and tune-in the signal on the gang condenser. Adjust the antenna trimmer (or 1,400 kc. trimmer) for maximum signal. Next set the test oscillator at 600 kc., and tune-in signal on condenser to check align-



The Sonora model TW-49 table model receiver.

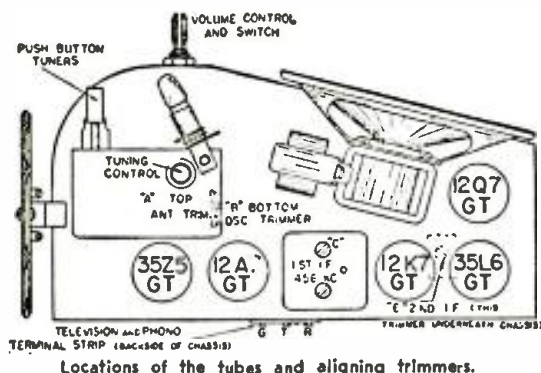

Locations of the tubes and aligning trimmers.

STEWART-WARNER MODEL 03-5A1 TO 03-5A9 (CHASSIS 03-5A) SENIOR VARSITY

5-Tube Superhet.; Self-Contained Loop Antenna; Automatic Volume Control; Broadcast Band; A.C.-D.C. Operation; Underwriters Approved.

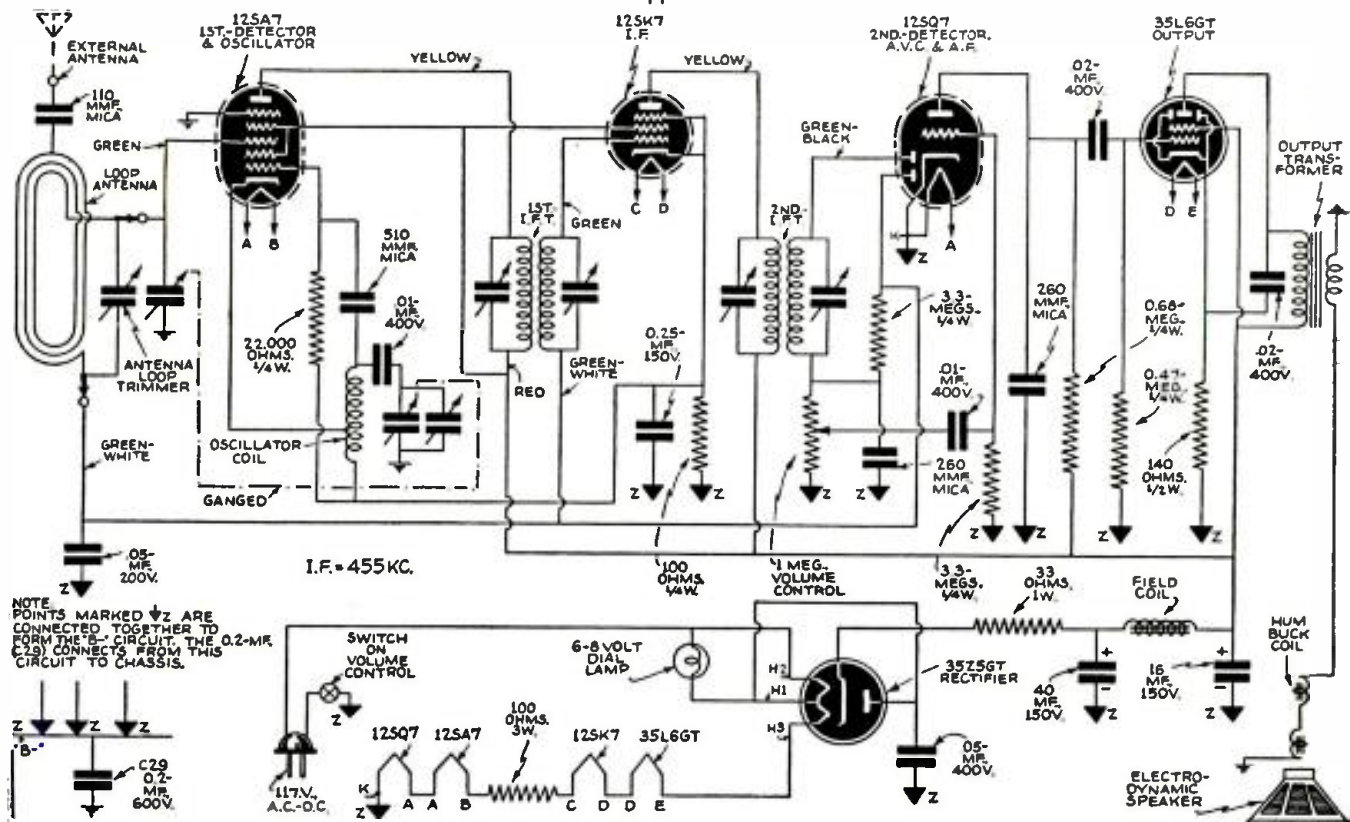

NOTE: POINTS MARKED Z ARE CONNECTED TOGETHER TO FORM THE "B" CIRCUIT. THE 0.2-MF. (C29) CONNECTS FROM THIS CIRCUIT TO CHASSIS.

I.F. = 455 KC.

ALIGNMENT PROCEDURE

An output meter and an accurately calibrated signal generator are required.

- Connect the output meter across the voice coil; or, using a condenser in series, connect between the plate of the 35L6GT output tube and "B-" as shown on the voltage chart. The more sensitive type should be connected across the voice coil.
- Connect the ground lead of the signal generator to the "B-" lug (shown on the voltage diagram) through a 0.25-mf. condenser and keep it connected in this manner throughout the entire alignment procedure. Failure to do this may have serious results, as one side of the power line may be grounded in the signal generator, or hum may be encountered.
- Turn the volume control to the maximum volume position and leave it in this position throughout the entire alignment procedure.
- TO CALIBRATE THE DIAL—Remove the chassis from the cabinet and set it on a flat surface (insulated from ground). With the gang in full mesh, the last dial division (just below 55) on the low-frequency end, should be exactly 4 3/4 inches above the table surface. If this is not the case, release the setscrew in the collar which connects the gang condenser shaft with the tuning unit, and holding the gang in full mesh, turn the dial until the last division is exactly 4 3/4 inches above the table surface. Now re-tighten the setscrew in the collar. The 4 3/4 inch division on the ruler (when measured vertically from table surface), is to be used as the dial indicator for all calibration and alignment.

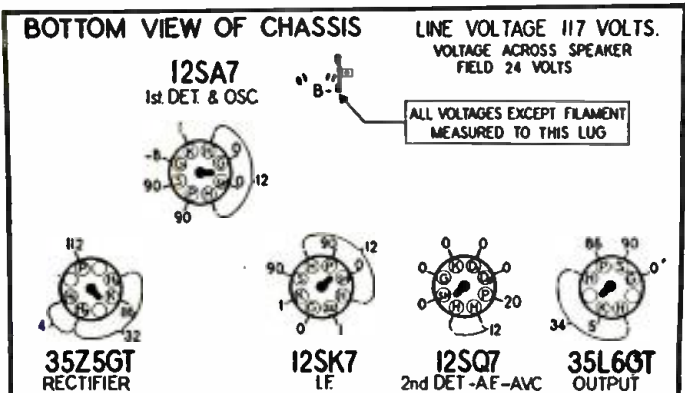

Socket voltages. Use a high-resistance voltmeter of at least 1,000 ohms/volt. Ground the antenna and tune the dial to 540 kc.

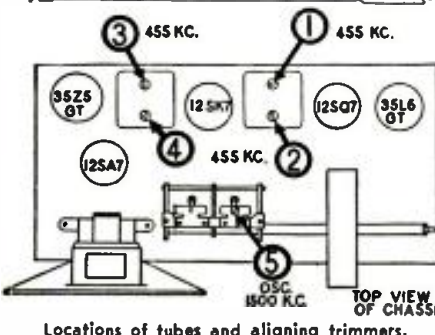
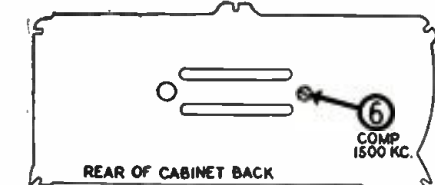

Dummy Ant. In Series with Signal Generator	Connection of Sig. Generator Output to Receiver	Signal Generator Frequency	Receiver Dial Setting	Trimmer Number	Trimmer Description	Type of Adjustment
0.1-mf. Condenser	Green wire of Loop (loop must be connected)	455 KC.	Any point where it does not affect the signal	1-2	2nd I.F.	Adjust for maximum output. Then repeat adjustment.
200 mmf. Mica Condenser	"Ant." Terminal	1500 KC.	1,500 kc.	3-4	Broadcast Oscillator (Shunt)	Adjust for maximum output.
200 mmf. Mica Condenser	"Ant." Terminal	1500 KC.	Tune to 1,500 kc. Generator Signal	5	Broadcast Antenna (Shunt)	Adjust for maximum output. Then re-adjust as explained below.

Now remove the output meter and signal generator connections and replace the set in the cabinet. Replace the cabinet back and MAKE SURE THAT THE GREEN WIRE GOES TO THE UPPER RECEPTACLE OF THE LOOP AND THE GREEN-WHITE WIRE TO THE LOWER RECEPTACLE. Place the antenna lead from the signal generator near the back of the cabinet and turn the output up until the 1500 KC signal is weakly heard. Adjust trimmer No. 6 for maximum output by ear.

IMPORTANT: In order to get maximum sensitivity, trimmer condenser No. 6 (marked COMP. on back of cabinet) should be adjusted for maximum volume on a weak signal near 1400 KC. This should be done every time an external antenna is connected or disconnected.

The 03-5A chassis is used in the Senior Varsity receiver equipped with a loop antenna. This chassis is very similar to the 03-5B and 07-5B Senior Varsity chassis except that the loop antenna has been substituted for the antenna coil.

To get maximum sensitivity from this receiver, it is absolutely essential to adjust the antenna compensator on the back of the receiver for the particular antenna actually used.

IMPORTANT—Due to this circuit, all voltage measurements must be made from "B-" instead of from chassis (see voltage chart). Also, during alignment, one side of the signal generator and the output meter must connect to "B-" instead of to chassis.

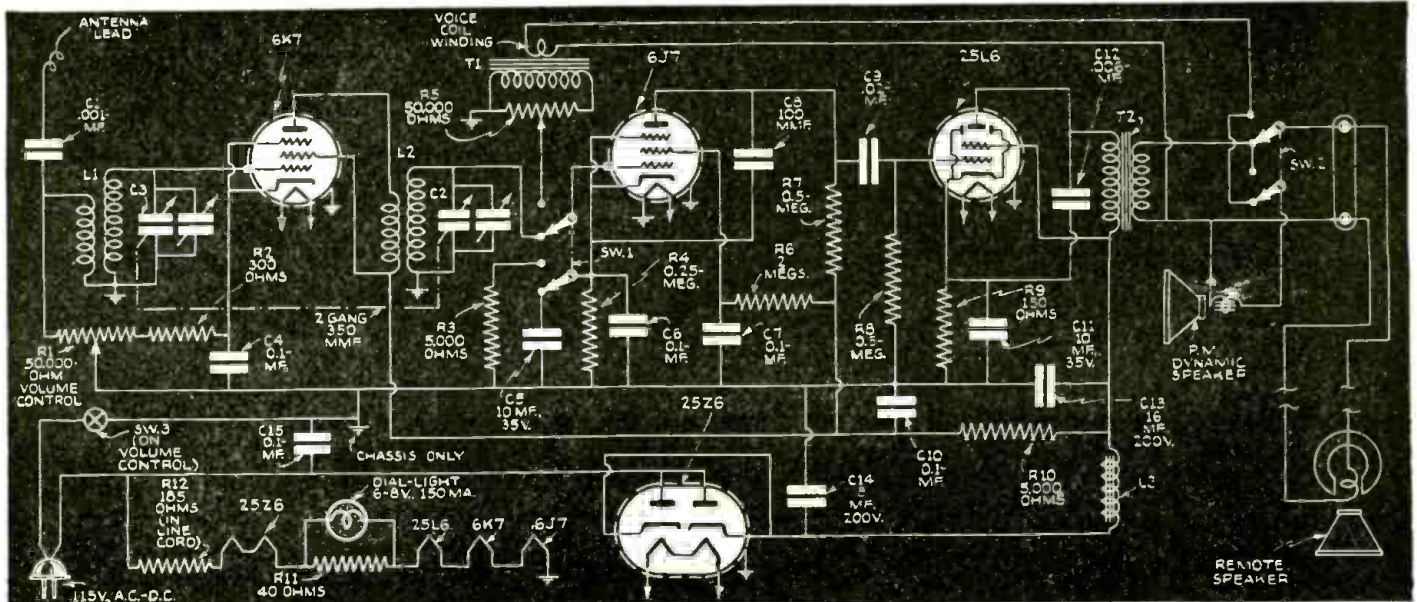

Fig. 1. Schematic circuit of the Com-Rad. Note that there should be no exposed pieces of metal connected to the chassis since the chassis is grounded to one side of the light line. An external ground is not used. Switch Sw.2 makes 2-way conversation possible with just the one Com-Rad unit.

RADIO *and* INTERPHONE

The device here described by Mr. DeVoe may be hard on itinerant salesmen but it certainly saves steps for the housewife. This dual-service radio set requires only remote speaker-mikes—one or more—to serve also as an intercommunicator.

DENNIS DeVOE

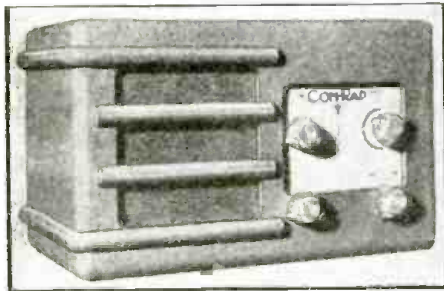

Photo of the completed Com-Rad.

YOUR recent article, "A Home Wired for Radio" encouraged me to submit the following details of a communicating radio set which has enjoyed good public acceptance in general, and the enthusiastic approval of housewives in particular. The original purpose of the device was to provide communication from front door to kitchen; and also radio reception for the kitchen.

Many women spend the greater part of the forenoon in the kitchen. In a busy city, from 5 to 10 times each morning, the woman of the house is forced to drop her cooking or other kitchen duties to answer the front door. A conservative estimate will show that 80% of these calls are useless time wasters for the woman. Solicitors, book salesman, etc. It was to do something about this condition that I built this little instrument, which, for want of a better name, I called "The Com-Rad," using the first 3 letters from COMMunicating and RADio.

There is nothing elaborate about the

radio itself, being a simple 4-tube A.C.-D.C. type using a hot cord, with switches placed in such a manner as to quickly change it to a conventional "talkback" system.

There are no "bugs" and any Serviceman can build such an instrument, making such changes as he sees fit. However, and after considerable experimenting, the circuit shown in Fig. 1 proved very efficient. Cost of parts exclusive of cabinet was about \$10.50.

A selector switch if wanted can be provided to connect to any one of 4 or 5 remote speakers.

TECHNICAL DETAILS

The changeover switch Sw.1 must be of the flat rotary type. The one used was a Centralab. This type of construction is necessary because a switch of the spring blade type presents too much capacity and will cause local stations to play through when the switch is in talkback position. This switch changes from radio to talkback by changing the control-grid of the 6J7 from the stator of C2 to the arm of R1. At the same time changing the bias resistor value and bypass condenser value of the 6J7. Sw.2 may be the same type as Sw.1; or any other 2-position switch.

It is, of course, necessary to have the R.F. coils at right-angles to each other, one placed below the chassis and one above (antenna coil on top).

The reason for using an A.C.-D.C. circuit was to save myself the trouble of shielding transformer T1 from the annoying field of a power transformer.

The chassis layout may be altered as

long as R5, T1, Sw.1 and C2 are kept close together to provide a short grid lead for the 6J7. No shielding was found necessary.

Unit T1 is the same type as T2. This proved to be very satisfactory, for although some gain was lost by using an output transformer for a voice coil to grid, the lower impedance of such a transformer made it unnecessary to shield any wires.

The hum level in the talkback position

(Continued on page 311)

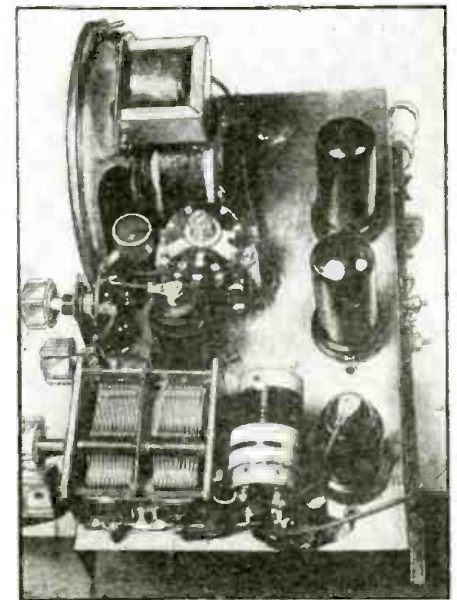

View of the completed chassis, showing placement of the more important units which comprise the Com-Rad.

All the worthwhile
Radio Trade News
of the past Month—
Digested for busy
radio men.

RADIO Trade Digest

A PLEDGE: — To
print the important
news of the radio
industry; to review
major news events;
to help point a path
to radio profits.

IMPORTANT HAPPENINGS OF THE MONTH IN THE RADIO INDUSTRY

No. 15

NOVEMBER, 1939

No. 15

SERVICEMEN & BCSTRS. IN PROMOTION TIE-UP

*RSA Plans Programs to Boost Biz—
Also Honors Mfrs. & Starts
Telly Course*

Beginning in the early Fall, a program of complete cooperation between broadcast stations & local RSA Chapters will be carried out through a plan developed by RSA & NAB.

The Executive Secretary of RSA, Joe Marty, Jr., a guest of the Convention of the National Association of Broadcasters at Atlantic City, addressed the Convention on "The Missing Link in Broadcasting." He showed how the Serviceman is the "good-will ambassador" of the radio industry in the American home. Marty told in detail to the 420 American Broadcasters represented at the Convention, the complete story of RSA. He pointed out that the Servicemen of RSA were in a unique position to help both themselves and the broadcasters. The reaction to his remarks was very favorable, and the groundwork was laid for complete cooperation between RSA and NAB. Several promotion broadcasts are planned for this autumn.

(Continued on page 312)

FARNSWORTH REACHES MARKET



Nearly 3 doz. models feature the new Farnsworth-Capehart line; former has 28 models alone, ranging from midgets to comboconsoles; higher-priced Capehart runs to \$2,500. Shown above is typical small Farnsworth 2-band table job (model AT-50), listing under \$30., with p-b tuner 'n' everything but the bracelet.

Tube Committee Meets To Review Situation

The first meeting of the Tube Committee of the National Radio Parts Distributors' Assn. met in New York late this summer in its first assembly. All Eastern members attended under the chairmanship of Maurice Despres.

The whole tube situation was reviewed and certain problems affecting the replacement tube market were

(Continued on page 313)

BIG IMAGES NEEDED TO BOOM TELEVISION?

*Sagall of Britain & Peck of U. S.
See Home-Movie Size
Images Wanted*

Despite the fact that telly is winning enthusiastic adherents throughout the U.S., two leaders in the optical scanning field feel that larger images are needed in order to bring a real television boom.

In an exclusive statement to Radio Trade Digest, Solomon Sagall, managing director of Scopphony, Ltd., emphatically denied that his company is about to abandon optical scanning methods in favor of the cathode-ray tube, now in general use. He indicated that, as the C.-R. tube has been known for some 30 years, it was available to all, including Scopphony, but that Scopphony does not want it.

His company, says Mr. Sagall, has "taken the view that nothing smaller than pictures approximating home movies will ultimately satisfy the viewing public," and adds that recent experiences in England prove the truth of that statement. "It is now an open secret in radio manufacturing circles," he con-

(Continued on page 312)

MATS HELP SERVICEMEN MAKE SALES

Our "RADIO NOISE DETECTIVE" CAN FIND THE TROUBLE... and Cure It Too!

Don't always blame your radio if it is noisy—if you are bothered with hissing, crackling, buzzing, popping, or other annoying sounds. Radio noises are usually caused by noisy electrical appliances, motors, flashing signs, oil burners, etc. and nothing but them can do the radio itself any harm.

STOP NOISE AT ITS SOURCE

By means of new Sprague equipment developed by the world's leading manufacturer of radio filters, we now offer radio noise elimination service that is quick, accurate and completely effective. The work is done where it should be done—at the place where it originates. Also, your radio set is checked thoroughly to make sure it is in best class condition.

Write for check-up of any radios that may be interfering with the full enjoyment of your sets.

Phone

WE LOCATE THE TROUBLE AND FIX IT ONCE AND FOR ALL

DEALER'S NAME AND ADDRESS HERE

Mats of 4 newspaper ads (3 shown) are made available to Servicemen at cost by Sprague Products Co. Sizes are 50 x 1 & 52 x 2 col. Purpose is to build interference elimination biz.

GET RID OF RADIO NOISES!

Don't have a noisy radio in your home? Get rid of those bothersome hissing, crackling, popping sounds that interfere with perfect radio reception. Many of the worst noises are not caused by the radio itself but are picked up from nearby motors, electric appliances, physical equipment, flashing signs, and the like.

A QUICK CURE

Let our radio "doctor" check up and show you how your receiver can be made amazingly quiet and clear—noise never can be eliminated all the way by the new Sprague method developed by the world's largest maker of radio filters. The work is quick, accurate, and completely effective. Write for "Radio Noise" literature gladly given.

SPRAGUE NOISE FILTERS

Get your radio expert to make a complete check-up of your set. Try our noise filters. They are guaranteed to stop the noise. Price \$1.00.

DEALER'S NAME AND ADDRESS HERE

STOP RADIO NOISE!

Radio noise? Bothered with hissing, crackling, popping sounds that interfere with perfect radio reception? Then let us check your radio set with our amazing new Sprague method, recently developed by the world's leading maker of condensers, filters and other radio parts. We'll find where it originates—in motors, electric appliances, and burners, electric signs, etc. in or near your home.

DEALER'S NAME AND ADDRESS HERE

Britons Get C-R Projection in Home Sets

Television images 18 x 14 1/2 ins. projected from a 4-in. C-R tube are a feature of the Philips Model 61, just shown at Radiolympia, London. Tube requires 25,000 volts on the anode; sells for about \$600.

WINDOW DISPLAY PUSHES TELLY TUBES

RCA TELEVISION KINESCOPE

See this display in your window. It's the new RCA 6-color television kinescope. It's the new RCA 6-color television kinescope. It's the new RCA 6-color television kinescope.

RCA Powertube distribs are now getting this 6-color display, which features an exact glass reproduction of a 12-in. Kinescope. Even if telly isn't working yet in your locality, the display carries a good prestige slant & curiosity appeal.

FOUR OF THE FOREMOST—MEN WHO MADE NEWS THIS MONTH



Left to Right—C. H. Thordarson, founder & pres. of Thordarson Electric Mfg. Co., was awarded Cross of the Icelandic Falcon Order, highest honor given by Danish & Icelandic govts. 72-yr.-old Mr. Thordarson received the honor for his work in perfecting the transformer & for his collection of ancient scientific works. He came to America from Iceland 66 years ago. (Award in inset.) Alfred A. Ghirardi, radio writer & consultant, back from 6-mo., 19,000-mi. auto

trip, finds dealers hopped up on telly & portables. George W. Henyan, for the past 9 yrs. sales mgr. of G-E's radio dept. at Schenectady, has just been made mgr. of the xmtr. & tube sales divs. of the co.'s new radio & telly dept. He's been with G-E since 1916, except during the World War. Roscoe Kent, formerly of De Forest, Wired Radio, & Muzak, has been made sales mgr. of all Finch Telecommunications Labs. fancy apparatus; he has 20 yrs. of sales experience.

\$'s & N^o. 's Dept.

IDEAS PAID \$32,570 to G.E. employees during the first 6 mo. of '39. More than 15,000 new ideas were submitted of which nearly 1/3 were accepted.

INCOME UP for RCA in 1939 with total gross \$23,285,124 or nearly a million ahead of '38. No, Agnes, this is not for the year, but for the 3 mo. ending June 30. Take for first 6 mo. was over \$48,000,000 or nearly \$3,000,000 ahead of '38. Net for first 6 mo. neared \$5,000,000—with net profit exceeding \$2,000,000 but still slightly below preceding yr.

TIME SALES UP, 69% for CBS, 29% for MBS and 11% for NBC, according to *Radio Daily*.

G.E. BIZ BOOMED 12% ahead of last year in first half of '39. Better yet, profits zoomed 24% to over \$16,000,000. (Continued on page 313)

Sales Helps and Deals

Aids To Profits, as Devised By Industry Leaders

Sprague Products Co., North Adams, Mass., is offering dealers mat service plugging use of modern methods to eliminate much radio noise. Mats illustrated on Pg. 289 measure 52 lines single- or 50 lines double-column & are offered at cost of mat, the co. bearing all expense of artwork, original plates, etc.

Arcturus Radio Tube Co., Newark, N. J., has 4 new displays plugging mfr's tubes for home use. Main unit is 18 x 28 ins. Three smaller ones also available, featuring metal-, glass- and G-type tubes. All are colorfully lithoed on heavy board, & are available free to dealers & distrib. Additional sets are scheduled for release soon.

Philco Radio & Television Corp. (Continued on page 313)

OFF THE PRESS

To Keep You Informed

SOUND OF TOMORROW, CAT. NO. 139. The Webster Co., Chicago, Ill. 24 pp. Lists co.'s amplifiers, power systems, record changers, communicators, sound systems, accessories, etc.

SOUND EQUIPMENT. RCA Mfg. Co., Inc., Camden, N. J. 60 pp. Complete data on recorders, mikes, P.A. systems, speakers, accessories, components & similar equip't.

TELEVISION. General Elec. Co., Schenectady, N. Y. 8 pp. Explains television to stockholders.

UTAH SPEAKERS. Utah Radio Products Co., Chicago, Ill. 32 pp. Besides speakers, lists vibrators, transformers, volume controls, plugs, etc.

CONFIDENTIAL NET PRICE CATALOG. Meissner Mfg. Co., Mt. Carmel, Ill. 48 pp. Full data on coils, transformers, kits, converters, etc., with dealer nets.

VIBRATOR REPLACEMENT GUIDE. Same co. 12 pp. Alphabetical listing of makes & models with vibrator requirements. Special section on buffer condenser replacements.

NEW-MATIC AUTOMATIC ANTENNA. Ward Products Corp., Cleveland, O. Single sheet on air-operated auto antenna.

CATALOG. International Resistance Co., Phila., Pa. Includes data on many new I.R.C. products such as attenuators, power rheostats, etc.

REPLACEMENT TRANSFORMER GUIDE (Bulletin No. 391-RG). Jefferson Elec. Co., Bellwood, Ill. 32 pp. Alphabetical listing by mfrs'. names of transformer requirements for standard sets.

TRANSFORMERS AND CHOKES. Same co. 16 pp. Specifications & prices of great variety of transformers & chokes.

FOLDER. Radio Wire Television, Inc., N.Y.C. 4 pp. Explains reasons for change of co. name from Wholesale Radio Service Co.

FOLDER. Farnsworth Television & Radio Corp., Fort Wayne, Ind. Pictures & descriptions of co's new line of radio receivers.

CREI. Capitol Radio Engineering Institute, Washington, D. C. 48 pp. Illustrated catalog showing coverage of courses and introducing new television course.

CAPACITOR REPLACEMENTS. Aerovox Corp., New Bedford, Mass. 4 pp. Gives data on refrigeration capacitor aids, including a capacitor selector & emergency capacitors.

TRANSFORMER CATALOG NO. 400D. Thordarson Electric Mfg. Co., Chicago, Ill. 24 pp. Complete data on all transformers, plus a few words about amplifiers & oscilloscopes.

TRADE PRACTICE RULES. Federal Trade Commission, Washington, D.C. 16 pp. A MUST for all radio receiver mfrs. Tells what constitutes unfair practices in radio industry. Get a copy if you want to stay out of trouble.

SALES & ENGINEERING EXECS AT NAB MEETING



This group of RCA sales and engineering execs. attended the annual meeting of the National Association of Broadcasters at Atlantic City. They are: back row (L. to R.)—Russel P. May, sales eng. in the N. Y. office; W. P. Dutton, television project eng. at Camden; Thomas Hall, of the service dept. in Camden; B. Robins, of the test equipt. engineering section, Camden; T. H. Smith, mgr. of telly sales, Camden; E. M. Washburn and E. S. Winlund, of the xmtr. equipt. eng. dept., Camden. Second row (L. to R.)—W. M. Witty, mgr. of S.-W. xmtr. equipt. sales office, at Dallas; Ben Adler, mgr. of N. Y. xmtr. equipt. sales office; G. Warren Kimball, service dept., Camden; C. Slaybaugh, xmtr. equipt. sales representative, N. Y. office; Jack Calvin, and A. N. Curtis, product design eng. dept. at Indianapolis; W. L. Garnett, project speech input eng. of Camden; C. M. Lewis, mgr. of speech input equipt. sales at Camden. First row (L. to R.)—D. A. Reesor, of Atlanta, manager of the S.-E. dist. office for xmtr. equipt. sales; Paul V. Yutz, in charge of bcst. equipt. advtg. at Camden; A. R. Hopkins, of Chicago, mgr. of central xmtr. equipt. sales office; J. P. Taylor, xmtr. equipt. sales eng., Dallas; S. W. Goulden, comm'l. eng. in the xmtr. equipt. division, Camden; and H. C. Vance, mgr. of facsimile equipt. sales, Camden.

AN EDITORIAL

By Artie Dee

Those extra dollars of profit come to the man with the Open Eye. Sure, your service business comes in because of your location, reputation, and advertising, but the extra business that means extra profits is won only by the man who watches for it to stick its neck out, and then grabs it before it can get away.

November is right around the corner, and it's a month that's loaded to the gunwales with opportunities for extra cash. And we all can use plenty of that!

Three Chances

Is there an election coming up in your locality? If so, sell or rent P.A. systems to the political clubs and candidates. Is the High School running a Thanksgiving entertainment on one Thanksgiving Day or another? If it is, it can use a P.A. system. Will the local veterans' post hold an Armistice Day parade? If they plan one, maybe they can use a sound system for the speeches.

What with the quality of sound apparatus going up, and the prices going down, there's a better chance for you to make sales—and profits—this year than ever before. Your only investment will be in shoe leather, and wear and tear on your vocal cords.

To get this business, push doorbells. Visit the Principal of the high school and tell him how much better the proud poppas and mommas will hear their talented offspring if you put a sound system in the auditorium. Call upon the campaign managers of the candidates of all parties and explain to each that you can help his man's voice reach more ears and therefore more votes. Drop in on the local Post and show how sound will win wider publicity for that grand parade.

You have something to sell—something that people want. But they can't want it unless they know about it. It's up to you to tell them. A shrinking violet may win paeans of praise from passionate poets, but it doesn't win any dollars away from hard-headed business men. *Go get that extra business!*

SO YOU'VE GOT A STOCK?

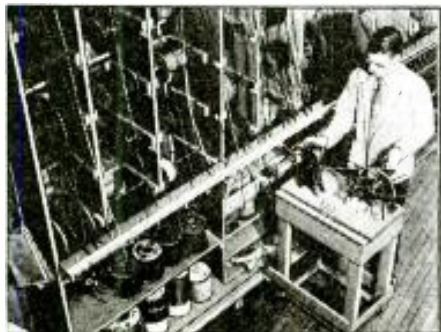

If you think you carry a stock of wire, take a look at this corner of the shelves in the Boston branch of Radio Wire Television, Inc. One reason the co. built such a big biz as Wholesale Radio Service Co. (its old name) is the tremendous stock it carries.

Changes & New Addresses

Save stamps & time! Address your mail right the first time!

JONES, McDUFFEE & STRATTON CORP., 367-377 Boylston St., Boston, Mass., now distributes G.E. refrigerators and air conditioners.

RADIO, LTD., a publication, has moved to 1300 Kenwood Rd., Santa Barbara, Calif.

New **STEWART-WARNER** distributors are Jenkins Music Co., 25 E. Reno St., Oklahoma City, Okla.; Tracey Wells Co., 173 N. Front St., Columbus, Ohio; The Hibbs Hardware Co., 5th St., Portsmouth, O.

H. W. Groetzinger, 1500 Cooper Ave., Pittsburgh, Pa., now represents **WARD-LEONARD ELEC.** radio products in western Pa. and throughout W. Va.

New **STROMBERG-CARLSON** distributors are Northern Radio Co., Seattle, Wash., for most of state of Wash.; Home Appliances, Butte, Mont., for western Mont.; Appliances, Inc., Cincinnati, O., for southern half of O. and part of northern Ky.

NEW SPEAKER LINE

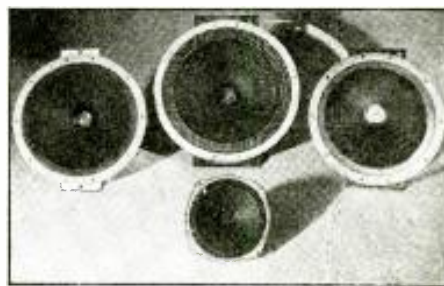

From 5 1/4 to 12 ins., the same speakers as are used in the Stromberg-Carlson 1940 sets are now available for P-A, extension, replacement & amateur use. Some have leather-edge suspension feature.

FACSY FACTS

W2XBF, N.Y.C., is on the air with facsy from 3 to 5 P.M. daily on 43.74 mc.



Auto Radio Dealers Assn., new eastern group, plans adv. campaign to promote biz . . . The *Capitol Radio Engineering Institute* is now offering a telly course for resident & home study pupils . . . There is a new baby in the *G.E.* portable line—a plug-in . . . Have you heard about the plan to have radio Servicemen (*R.S.A.* members) do an audience survey? Joe Marty, the assn. secy. can give you full dope . . . *Reiss Advt.*, N.Y., will handle *Radio Wire Television, Inc.* publicity just as when the co. had its former name—*Wholesale Radio Service*.

Finch is ready with the new facsy job that prints a full-size 5 col. tabloid page at the rate of 20 sq. ins. per min. (8 full pgs. per hr.) . . . Watch for frequency modulation—2 new stations working in Eastern U.S. and a third coming this Fall . . . (Tip to some live mfr.) Can you design a converter to catch freq.

mod. for standard best. sets? . . . Peaks in the auto-radio biz. are leveling off, according to Sayre Ramsdell, v-p of Philco, who says merely 7,000,000 such sets are now in use. . .

Stromberg-Carlson now has "wave wizard" for installation on any make or model of set not now loop-equipped. It is an aluminum shielded job somewhat different from the old-time socket aerial . . . Plans to plug *RCA* sound-equip't have been announced to the co.'s sales engineers and will be passed along to
(Continued on page 314)

RADIO-TELLY EXECs IN "LINE-UP"

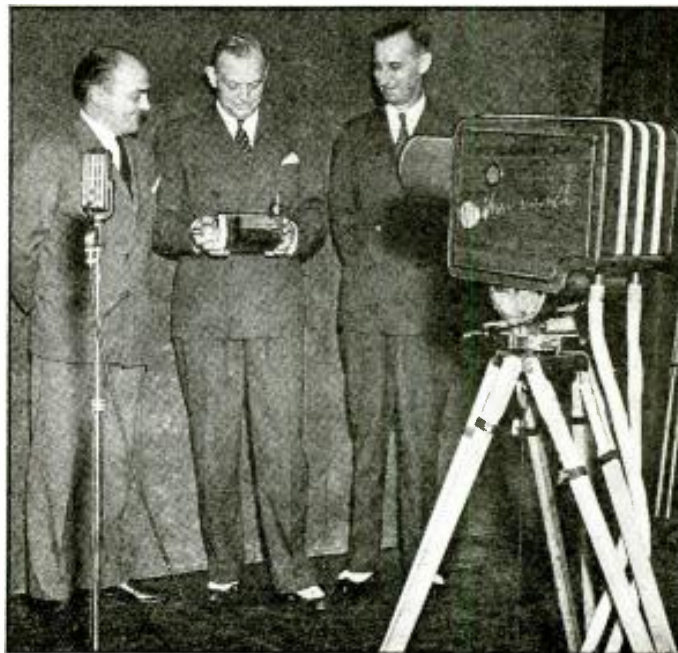

Three Farnsworth execs. in the co's telly studio at Ft. Wayne, Ind., are (L.) Ernest H. Vogel, v-p.; (R.) J. P. Rogers, v-p., treas. & supervisor of operations at the Marion, Ind., plant. Mr. E. A. Nicholas, pres., is holding an image dissector (pick-up) tube.

Personal

These men are worth knowing; meet them here.

S. N. SHAW, A. A. BERARD, H. E. OSMUN and JEROME J. KAHN were elected directors of the Radio Parts National Trade Show for the coming year. Osmun will also serve as secy. treas. KEN HATHAWAY was reappointed managing director of the Show.

GEORGE W. HENYAN, recently appointed mgr. of G.E. radio and transmitter tube sales, has been sales mgr. of co.'s radio dept. for past 9 years. Henyan, grad. of U. of Texas in '16, entered G.E. test dept. in the same year. From '17-'19 he was in the army, but except for that time has been with the co. continuously. He continues to make his hq. in Schenectady (see pic., pg. 290).

HARRY BOYD BROWN, nat'l merchandising mgr. of Philco, will address 11th annual Boston conference on distribution Oct. 2 and 3 at Hotel Statler; his topic—"Television Makes It Possible."

GEORGE I. MacLAREN has been made production mgr. of mfg. operations at the Zenith plant in Chi. Mr. MacLaren has had 14 yrs. of production experience with Atwater Kent and RCA.

HARRY TRACY will tell the world that Tracy & Co. has just been made Stromberg-Carlson dealers. He tossed a banquet in Providence, R. I., to introduce the 1940 line.

MAURICE McCALL will direct the newly-formed technical dept. of Stewart-Warner. Mac, formerly in the co.'s service dept., will be responsible for preparation of specs., cataloging and pricing of Stewart-Warner's accessories.

ROSCOE KENT, ex. of DeForest, Wired Radio, and Muzak, has been made sales mgr. of all Finch facsimile apparatus. (See pic., pg. 290.)

IAN C. JAVAL, commercial director of Baird Television Corp., sailed for England on a biz. trip. (Continued on page 314)

STARTLING STYLING MARKS MIDGETS



Ten new Little Nippers of unusual cabinet design mark the new RCA line. Two have "Magic Voice"; all have built-in antennas & 5-tube superhet. chassis. At top, above, is "La Siesta"; below it, "N. Y. World's Fair". Other models include Golden Gate, Treasure Chest, Colonial, etc., from \$14.95 to \$18.75.

Salesman Sam Says

U.S. Bureau of Foreign & Domestic Commerce releases regular reports analyzing world radio markets for enterprising mfrs. & exporters.

GREENLAND—Outlook not too good; perhaps 80 to 100 sets are in use and not more than 20 to 30 per year are bought. No electric sets, no auto sets. Tubes and batts. are bought in Denmark.

IRAQ—Some 10,000 sets are now in use. Annual sales about 4,000; 6 to 10 tube sets preferred, and 80% are table models, with \$60 to \$110 A.C.-D.C. jobs tops. American tubes taken readily. Not many battery jobs.

NEWFOUNDLAND—Probably about 12,000 sets in use, 1,200 being bought in '38. Greatest demand for low-priced table jobs, working on 110 V., 60 cycles A.C. Seven & 8-tube table models dominant. Little market for auto sets. Tubes as might be expected.

CYPRUS—Only about 300 to 400 sets sold yearly, mostly 6 to 8 tube jobs. High polish on cabinet big sales point. Auto sets negligible. Tubes for replacement only.

HUNGARY—American sets selling 70% of market with over 419,000 in use. Budapest by far biggest market. About 1/2 of sets are 2-tube jobs. Others range up to 6 tubes. Auto sets don't sell. Few permits available for American tube imports.

Far more detailed information is available from the Bureau of Foreign & Domestic Commerce. Publications to request are: World Radio Markets covering countries wanted & The Electrical & Radio World Trade News.

MORE POWER TO YOU!



A 2-lb. "B" battery with a life-expectancy equal to one twice its size is the latest development of National Carbon Co. for portable sets. Name, Eveready Mini-Max, signifies minimum space, maximum power.



Series of 74 units comprises Meissner Mfg. Co.'s new vibrator line. Features include Swedish spring-steel center reed, sponge-rubber liner, and "aging" under test, plus careful adjustment.

Television Tips

Solomon Sagall, managing director of Scophony, denies rumors of switch to c-r system. For direct statement by Mr. Sagall, see pg. 289.

Telly is getting bigger play in U.S. as western and mid-west cities begin installation of demonstration equipment.

Execs of Radio Wire Television Corp. are praying that telephone co. will soon install coaxial throughout N.Y.'s movie palace area. Hope is that this will make possible selling special telly shows to local houses.

RCA men playing the State Fair circuit with "jeeps" report record crowds coming to gape at telly images.

Mourner's note! Major fight promoters in U.S. scowl at telecasts of major events as harmful to "draw". British promoters, concurring, are taking similar steps. In Britain, too, movie interests are thumbs-downing theatre installations.

RCA demonstrated 2-way telly at the N.A.B. convention at Atlantic City, N.J. Results included much interest and immediate orders.

For the book, W6XAO, Hollywood's only telly station, was on the air with 600 program hours in '38; 450 of those hours were live talent.

"ORGAN-FONIC" FILTERS TONE

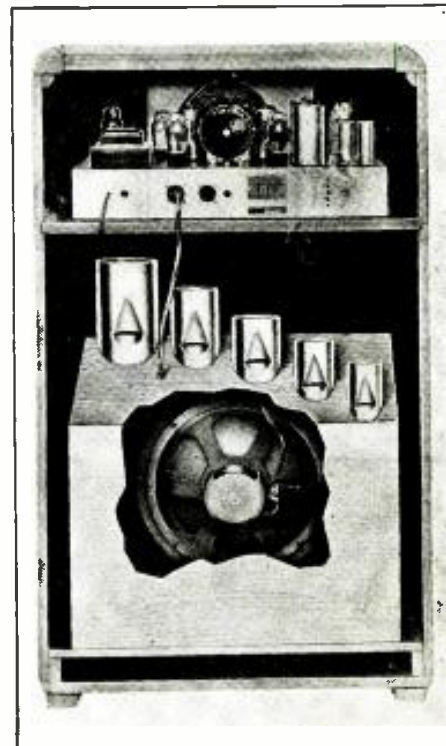

Sets of 6 to 17 tubes mark the new Midwest line. The big job covers 5 bands, has "Organ-Fonic" tone filter, Anten-A-Scope & p-b tuning. Pipes of graduated sizes are said to more than triple the baffle effect; special tone control affords "14 distinct vibrations" of tone.



THEY SAY: It's The Greatest Radio Catalog Ever!

204 PAGES, EXCLUSIVELY RADIO!

EVERYTHING IN RADIO AT LOWEST PRICES! Greater Selection, Bigger Values Than Ever Before! 5 Big New Sections!

Good news spreads fast . . . and Everyone in Radio is sending for this new 1940 ALLIED Catalog! Don't miss it—bigger, better, more complete than ever before, it places every radio need at your finger-tips, shows you **EVERYTHING IN RADIO at LOWEST PRICES**. 5 complete new sections, for Dealers, Servicemen, Amateurs, Sound Specialists, and Builders—showing the newest Sets, Kits, P.A., Recording Equipment, Ham Gear, Test Equipment, books, tools, and more than 15,000 parts, all organized conveniently for quick and easy reference, and every item an outstanding value. Send for ALLIED's 1940 Catalog today!



Send For Your FREE Copy Today!

Remember, ALLIED'S business is exclusively radio supplies; it has been but one policy, one effort, and one interest: that of fulfilling your radio needs in the most satisfactory, speedy and most economical manner. You'll find it always pays to buy at ALLIED.



60 NEW SETS
Greatest set values in ALLIED's history! 60 new Knight models, 4 to 12 tubes, featuring built-in Air-Magnet Aerials and new Push-Button Tuning. New lower-priced portables—1 1/2-volt models. AC-Battery, strap-type, etc.—new plastic cabinets. —sets for every purpose—and phonographs (1-tube electric, etc.)—phono-radlos (3, 7, 11 tube)—new recorder-phono-radio combination—cabinets, complete phono accessories—they're all in ALLIED's new catalog at lowest prices. Send coupon today.



P.A. 3 NEW LINES
Now, "Economy," "Standard" and "De Luxe" lines—13 new systems, portable, 6-65 watts, permanent.—8-65 watts. New beauty—utility. New systems for 110 volts AC-DC, battery, 32 volts, etc.—20-watt with built-in phono, new Power Stages, etc. Also new Knight "mikes," complete recording equipment and P.A. accessories, new low-priced discs, etc. Hearing Aid, and other specialties.
New Time Payment Plan
Lowest carrying-charge, easiest terms. See ALLIED'S 1940 Catalog.

ALLIED RADIO CORPORATION
111 W. JACKSON BLVD. CHICAGO, ILL.

A MESSAGE TO EVERYONE IN RADIO

The 1940 ALLIED Catalog is the largest we have ever published. Its 204 pages offer a wider selection of radio equipment for Everyone in Radio -- for Serviceman, Dealer, Amateur, Builder, Dealer and Sound Man. Most important of all -- our prices have never before been so low. This larger catalog is the symbol of ALLIED's determination to give constantly better service to its many radio customers. Against a background of 17 years, ALLIED has consistently specialized in Radio -- it is our 100% interest -- our one and only goal. This 100% Radio policy is, we feel, the only way in which we can continue to give you at all times the ALLIED high standard of service and value on you have come to expect. I am proud, on behalf of all of us here at ALLIED, to bring you our new 204-page 1940 Catalog -- devoted exclusively to radio -- for Everyone in Radio. I sincerely believe that you will find it the most complete and value-packed, money-saving catalog you have ever used.

Sincerely yours,
A. A. Adams
President
ALLIED RADIO CORPORATION



HAM GEAR! ALL LEADING LINES
The largest Ham Section ever published!—every receiver, transmitter, transceiver from every leading line spread before your eyes at lowest prices! All newest receivers, Sky-rider "DeLant," Television equipment, Rotary Beam equipment, etc. 20,000 Amateurs buy from ALLIED, because ALLIED knows Ham problems, needs, desires. Get this big new Catalog today!
New Time Payment Plan
Lowest carrying-charge, easiest terms. See ALLIED'S 1940 Catalog.



PARTS! BIG NEW SECTION
See the latest new type tubes—110, 117 volt, etc.—thousands of exact duplicate and replacement parts for every need. Dozens of new kits, Beginners' 1, 2, and 3 Tubes, Wire-less Phono, 1 1/2 volt. etc.—Free Parts Lists. Complete section of the latest Test Equipment from every leading manufacturer. Complete line of latest accessories. New Big Parts section—and over 15,000 quality items. "Everything in Radio at lowest Prices" in one big book. Send for a FREE Catalog today!

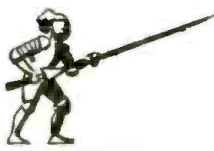

And a Big New Bargain Section Where Prices Meet their Waterloo!

Specials, every one!—the country's biggest radio bargains, in the special color section. Don't miss these values!

ALLIED RADIO CORPORATION

833 W. JACKSON BLVD. CHICAGO

ALLIED Radio Corporation,
833 W. Jackson Blvd.,
Chicago, Ill., Dept. 2-L-O

FREE SEND COUPON

Send your FREE 204-page Radio Catalog.

Name

Address

City State

Please Say That You Saw It in RADIO-CRAFT



RADIO— MANY OPPORTUNITIES STILL AHEAD

• The radio industry has hit its full stride! The future, with Television, presents great opportunities—for the trained man! The I. C. S. Radio Course, prepared by experts in practice as well as theory, is constantly revised to meet new developments. This Course can make you a trained man — prepare you for promotion and a trained man's salary! Send for free booklet.

INTERNATIONAL CORRESPONDENCE SCHOOLS

Box 6680-E, Scranton, Penna.

Send me—free—information on subject checked:

- Radio
- Radio Operator
- Radio Service Man
- Electrical Engineer

Name.....

Address.....



old man (Call me Gutenberg)
Centralab
is busy in Ye Old Print Shoppe
pulling impressions of the new
**1939-40 Centralab
Supplement**

an 80 page opus that brings the
new replacements out into the
light and reveals the "goings on"
in the world of new Volume Con-
trol assemblies. No well-regulated
service shop can afford to be
without one . . . Yours for the
asking at your jobber.

Don't, for goodness sakes, let 'em
stump you when they bring in a
new 1940 model.

Centralab

- RADIOHMS
- FIXED RESISTORS
- WAVE BAND SWITCHES
- LOW CAPACITY LEVER ACTION SWITCHES



VOLUME CONTROL GUIDE

1939 SUPPLEMENT

Div. of GLOBE-UNION Inc., Milwaukee, Wisc.

THE LATEST RADIO EQUIPMENT

These new radio products are so laid out that they may be conveniently referred-to when writing to manufacturers for additional information.

AUTOMATIC AUTO ANTENNA HAS "NON-STOP" CONTROL

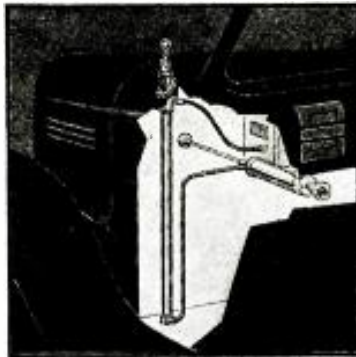

RCA Manufacturing Co.
Accessories-Test Equipment Division Camden, N. J.

THE NEW RCA automatic auto antenna, which is simply operated by a compact pneumatic plunger mechanism conveniently located beneath the dashboard, may be instantly adjusted in length from the driver's seat. With only a stroke or two of the plunger, the antenna may be extended or retracted without leaving the car. Finished in durable chromium, it measures 42 ins. when fully extended and provides signal strength greater than antennas 1/3 longer since it is not shielded by the engine hood.

November 1939 *Radio-Craft*

NEW TELEVISION TESTER

The Triplett Electrical Instrument Co., Bluffton, Ohio

DESIGNED especially to service television instruments where high voltages are invariably present. Special test leads, 3 ft. long, have been tested to 25,000 V. breakdown. Posts are provided on the panel for grounding the metal case which is a sure protection against bodily injury at high voltage. Tests A.C. and D.C. voltage in steps of 2,500 and 10,000 V.; D.C. microamperes in steps of 50, 500 and 5,000 micro-A. Meter sensitivity is 25,000 ohms/volt for D.C. and 5,000 ohms/volt for A.C. The meter is a 4-in. instrument in a bakelite case. Dimensions, 7-7/8 x 6 1/2 x 5-5/8 ins. overall.

November 1939 *Radio-Craft*



CABLE HANGER FOR MIKE STAND

Atlas Sound Corp., 1447 39 St., Brooklyn, N. Y.



THIS novel attachment permits the hanging of microphone cable on the microphone stand, and keeps the cable off the floor. A simple, but effective cast-aluminum clamp holds the hanger firmly in place without altering the mike. The finish is a dull aluminum which blends in with chromium and other finishes.

November 1939 *Radio-Craft*

5-BAND COIL SWITCHING ASSEMBLY

Barker & Williamson, Ardmore, Pa.

KKNOWN as "baby coil turrets," these assemblies consist of 5 coils mounted on a switch and cover the amateur bands from 10 to 160 meters. They are for use with any midjet condenser having an effective capacity of 100 mmf. Coil turrets are rated at 35 W. and are designed for use in low-power transmitters and exciter stages. The switches employ ceramic sections for the coil-ends where high voltage is encountered, and bakelite sections for center-taps and link terminals. Four distinct types are available for use in various types of circuits.

November 1939 *Radio-Craft*

(See page 296 for additional items)



Please Say That You Saw It in RADIO-CRAFT

THE MODEL 1110 A.C. - D.C. VOLT-OHM MILLIAMMETER

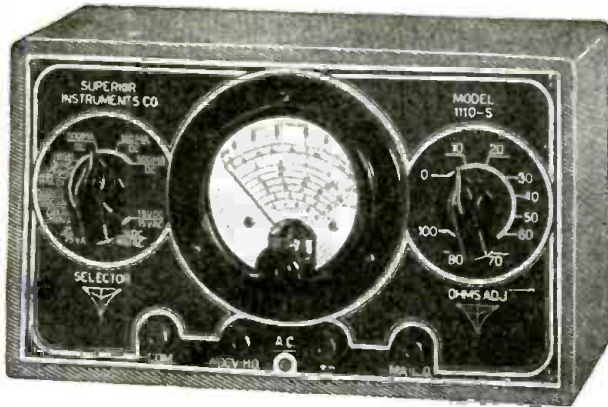

We could have priced this instrument for \$1.00 or even \$2.00 less by taking advantage of certain economies, which would not have made much difference in the performance of this instrument. However, we realize that this type of instrument must be built to withstand an unusual amount of abuse. We, therefore, used the very best of parts in designing and building this instrument. For instance, we use the same type of jewelled d'Arsonval type of meter as in our larger units, precision multipliers and shunts, positive contact switches and tip jacks, wire-wound ohms adjuster and an attractive etched aluminum panel. Thus at \$7.85, a low price for a pocket-size A.C.-D.C. Volt-Ohm Milliammeter, we offer an instrument which compares favorably with the same type of instrument selling at twice the price.

SPECIFICATIONS:

0-1.5 volts D.C.	0-500 ohms.....	500-500,000 ohms.	0-15 volts A.C.
0-15 volts D.C.	0-1 ma. D.C.		0-40 volts A.C.
0-25 volts D.C.	0-10 ma. D.C.		0-75 volts A.C.
0-75 volts D.C.	0-100 ma. D.C.		0-200 volts A.C.
0-500 volts D.C.	0-500 ma. D.C.		0-1200 volts A.C.

Model 1110-S supplied complete with batteries, test leads and instructions. Size 8 1/2" x 5" x 3 1/4". Shipping weight 5 1/2 pounds. Our net price **\$7.85**

THE NEW MODEL 1280 SET-TESTER

Combines Models 1240 and 1250

Here is Superior's answer to the demands of Radio Servicemen. A complete, all-purpose testing laboratory, the Model 1280 combines the Models 1250 Multitester and 1240 Tube Tester. (See specifications of each below.)



FEATURES

- Instantaneous snap switches reduce actual testing time to absolute minimum.
- Spare socket, and filament voltages up to 120 volts make the Model 1280 obsolescence proof.
- Latest design 4 1/2" d'Arsonval type meter.
- Comes housed in attractive, leatherette covered carrying case.
- Sloping panel for rapid, precise servicing.
- Works on 90-125 volts 60 cycles A.C.

Even these servicemen who through past purchases know they can always get SUPER-VALUES from Superior, will be amazed and delighted when they read the specifications of this all-purpose instrument and then note the unbelievably low price. The Model 1280 features a 4 1/2" d'Arsonval type meter for easy reading of the various scales, and in line with our new policy of stressing appearance as well as serviceability in our new 1200 line of test equipment, our Model 1280 utilizes an aluminum etched panel, designed for beauty as well as ruggedness. The primary function of an instrument is, of course, to make measurements accurately and when designing test equipment this is our first thought. However, we also appreciate the important part the appearance of an instrument plays in the impression a serviceman makes on his customers, especially on home calls. We have, therefore, paid special attention to the outward design of all of our new instruments. For instance, the panel of this Model 1280 is made of heavy-gauge aluminum and etched by a radically new process which results in a beautiful, confidence inspiring appearance.

Model 1280 comes complete with test leads, tabular data and instructions. **\$19.85**
Shipping weight 18 pounds. Size 13" x 11" x 6 1/2". Our net price
Portable cover \$1.00 additional.

THE NEW MODEL 1250 MULTITESTER

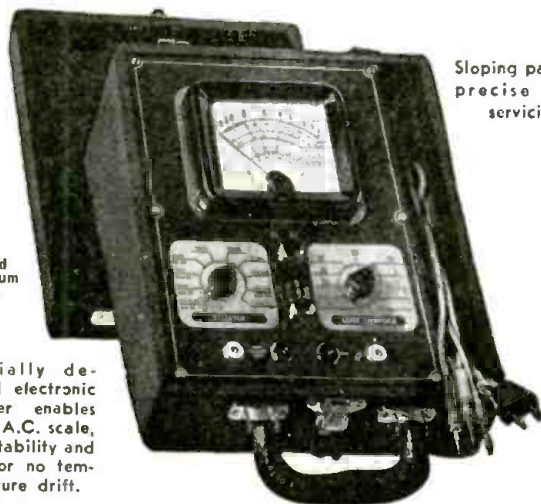

Sloping panel for precise rapid servicing.

Etched aluminum panel

Specially designed electronic rectifier enables linear A.C. scale, high stability and little or no temperature drift.

Here is an opportunity to acquire a Multi-Service, Precision Engineered Instrument, for less than you would have to pay for an ordinary Volt-Ohm Milliammeter. Besides making the usual volt, resistance and current measurements (both A.C. and D.C.) this unit accurately measures the CAPACITIES of mica, paper and electrolytic condensers, INDUCTANCE of coils, chokes, and transformers, DECIBEL gain or loss, of power amplifiers and public address systems, WATTS output of amplifiers, receivers, etc.

SPECIFICATIONS

Complete A.C. and D.C. Voltage and Current Ranges	High and Low Capacity Scales .0005 to 1 mfd. and .05 to 50 mfd.
D.C. Voltage:—0-15, 0-150, 0-750 volts	3 Decibel Ranges
A.C. Voltage:—0-15, 0-150, 0-750 volts	—10 to +19, —10 to +38, —10 to +53
D.C. Current:—0-1, 0-15, 0-150, 0-750 ma.	Inductance: 1 to 200 Henries
A.C. Current:—0-15, 0-150, 0-750 ma.	Watts: Based on 6 mw. at 0 D.B. in 500 ohms. 006000 to 600 Watts
2 Resistance Ranges 0-500 ohms, 500-5 megohms	

Model 1250 works on 90 to 120 Volts 60 cycles A.C. Comes complete with test leads, tabular charts and instructions. Shipping weight 9 pounds. Size 9 1/2" x 11" x 6 1/2". Our Net Price **\$11.85**
Portable Cover \$1.00 Additional

THE NEW MODEL 1240 TUBE TESTER



Instantaneous snap switches reduce actual testing time to absolute minimum.

Tests all tubes 1.4 to 117 volts.

Sockets for all tubes—
No adapters.

Superior is proud to offer the newest and most practical tube tester ever designed. Unbelievably low in price—unbelievably high in performance.

- ★ Tests all tubes, 1.4 to 117 volts, including 1, 5, 6, 7, 7L, octals, octals, Bantam Jr., 1-anut, single ended, floating filament, Mercury Vapor Rectifiers, the new S series, in fact every tube designed to date.
- ★ Spare socket included on front panel for any future tubes.
- ★ Tests by the well-established emission method for tube quality, directly read on the GOOD ? BAD scale of the meter.
- ★ Jewel protected neon.
- ★ Tests shorts and leakages up to 2 megohms in all tubes.
- ★ Tests leakages and shorts in all elements AGAINST all elements in all tubes.
- ★ Tests BOTH plates in rectifiers.
- ★ Tests individual sections such as diodes, triodes, pentodes, etc., in multi-purpose tubes.
- ★ Latest type voltage regulator.
- ★ Features an attractive etched aluminum panel.
- ★ Works on 90 to 125 volts 60 cycles A.C.

Model 1240 comes complete with instructions and tabular data for every known type of receiving tube. Shipping weight 12 pounds. Size 6" x 7 1/2" x 10 3/4". Our Net Price **\$11.85**
Portable Cover \$1.00 Additional

SUPERIOR INSTRUMENTS COMPANY
136 Liberty Street Dept. RC-11 New York, N. Y.

Please Say That You Saw It in RADIO-CRAFT

ACTUAL WORK ON
ACTUAL ELECTRICAL
MACHINERY

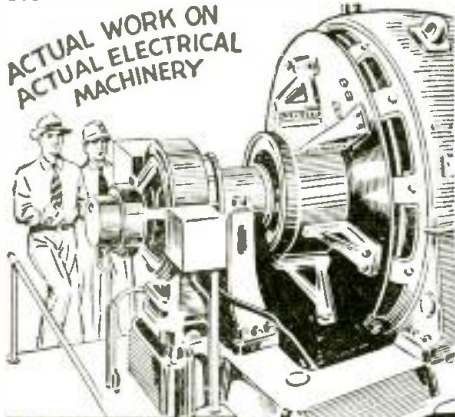

**TRAIN FOR
ELECTRICITY**
12 WEEKS SHOP TRAINING

**PAY TUITION
AFTER GRADUATION**

Are you out of a job? Are you working long hours at low pay in a job you don't like? Are you wondering where you can find a job that will give you steady, interesting work with better pay? If this applies to you and if you are between 16 and 40, then read every word of this message.

Get into a field where the opportunities are great and better salaries are paid. The huge billion dollar Electrical Industry is full of opportunities for men and young men. Build the foundation for yourself by training for 12 weeks in these fascinating, bigger-pay branches of Electricity—Power Plant work, sub-station operation, electrical maintenance, refrigeration and air conditioning, Diesel Electricity, construction work and many other branches.



GET A PRACTICAL TRAINING IN FAMOUS CHICAGO SHOPS

You must be trained to get ahead. The famous Coyne Shops in Chicago can train you for a start in Electricity in only 12 weeks—not by home study but right here in Chicago where you "Learn-by-Doing" on real equipment.

You don't need previous experience—you don't need advanced education. At Coyne you are trained on real motors, dynamos, generators. You wind armatures, do house-wiring, operate switchboards, work on electric refrigeration and air conditioning equipment, farm lighting plants, automobile ignition and many other branches of Electricity.

MANY EARN WHILE LEARNING

Employment Help After Graduation. A lot of my students work part-time to help with their living expenses. If you need this assistance my employment department will give it to you and after graduation you will get valuable employment and consultation service.

If You Are Short of Money My "Pay After Graduation" Plan Will Help You. I have a plan to help ambitious fellows who are short of money for their tuition. On this plan you can get your training with only a small down payment. Then, you pay the rest of your tuition in small, monthly payments starting 60 days after graduation and extending over a period of one year. Mail the coupon for the facts.

MAIL COUPON TODAY

You can't make the start to a better future unless you do something about it. Act now to make your dreams come true. The first step is simple. SEND THE COUPON FOR MY BIG FREE CATALOG AND ALL THE FACTS—TODAY!

H. C. LEWIS, President
COYNE ELECTRICAL SCHOOL
500 S. Paulina St., Dept. 89-78, Chicago

H. C. LEWIS, President
COYNE Electrical School
500 S. Paulina St., Dept. 89-78 Chicago, Illinois

Dear Sir: Please send me your big free catalog and all the facts about your "Pay After Graduation" plan as well as other details of your plans to help a fellow get ahead.

NAME.....
ADDRESS.....
CITY.....STATE.....

THE LATEST RADIO EQUIPMENT

(Continued from page 294)

CRYSTAL-CONTROLLED MICROVOLTER

The Hickok Electrical Instrument Co.
10514 Dupont Ave., Cleveland, Ohio

THIS new instrument has a self-contained vacuum-tube voltmeter, power level meter and crystal. It has over 250 crystal-controlled, modulated or unmodulated, outputs from 100 kc. to 15,000 kc. every 100 kc.; and from 1,000 kc. to 100 megacycles every 1,000 kc. Its accuracy is claimed to be better than 0.01-per cent. Direct calibration of continuously-variable R.F. output is from 1/2- to 100,000 microvolts on all ranges. A.F. output is calibrated from 0 to 1 V. The self-contained power level meter has 3 decibel ranges, viz., -10 to +6, +6 to +22 and +22 to +38 db. Seven R.F. ranges are calibrated directly from 100 kc. to 60 megacycles. A large 8-in. dial is used and is directly-calibrated in kilocycles and megacycles.



November 1939 Radio-Craft

"ANTENNA-SCOPE" LOOP

Consolidated Wire & Associated Corps., 524 S. Peoria St., Chicago, Ill.

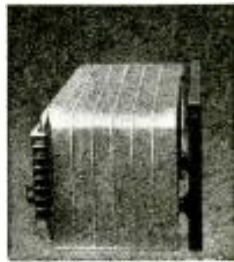

ESSENTIALLY a directional, portable loop, this antenna may be attached very easily to any broadcast receiver with 2 double vacuum cups provided with each unit. It may be matched to the inductance requirement of any receiver (T.R.F. or superhet.) by screwdriver adjustment of the iron-core permeability-tuned tracking coil. The "Antenna-Scope," the manufacturer claims, increases the signal-to-noise ratio, eliminates static and prevents noise induction through a high-Q circuit.

It is recommended to Servicemen as a replacement for antenna systems requiring the use of unsightly wiring. The unit is quite compact, measuring 6 1/2 ins. wide, 11 1/4 ins. long and 1/2-in. thick.

November 1939 Radio-Craft

PAPER-WOUND REPLACEMENTS FOR ELECTROLYTICS

Aerovox Corp., New Bedford, Mass.

TO MEET the occasional demand for paper-wound replacements for metal-can and cardboard-case dry electrolytics, 2 new condensers are now available. The PWC series, matching in size and shape the dry electrolytic metal-can condensers, is available in 3 types replacing the 4-600, 8-600 and 8-8-600 electrolytics, with actual capacities of 2, 2.75 and 1.75-1.75 mf., respectively. The PWP series match the cardboard-case dry electrolytics of 4-600, 8-600 and 8-8-600, with actual capacities of 2, 3 and 2.75-2.75 mf. These paper replacement units have extremely low power factor and leakage. No polarity need be observed.

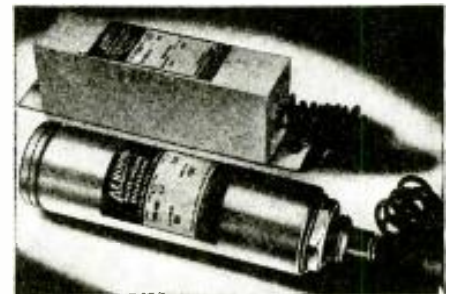

November 1939 Radio-Craft

COMPLETE P.A. SYSTEM INCLUDES PORTABLE MIKE-STAND

The Webster Co.
5622 Bloomingdale Ave., Chicago, Ill.

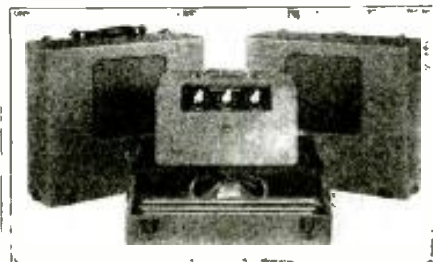

WHAT is claimed to be a "first" in radio is this complete P.A. system which boasts a portable floor-type microphone stand. The 2 loudspeakers fit together in the familiar manner, into a handy carrying case. This case, however, has a false-bottom which is utilized for carrying a full 47- to 60-in. length, easily assembled floor stand in 3 sections. With this system the singer's new gown can be seen and the bandleader needn't scurry about hunting a table upon which to put his microphone. The amplifier employed is a 14-W. job—the most popular rating for average P.A. installations.

November 1939 Radio-Craft

(See page 298 for additional items)

Please Say That You Saw It in RADIO-CRAFT

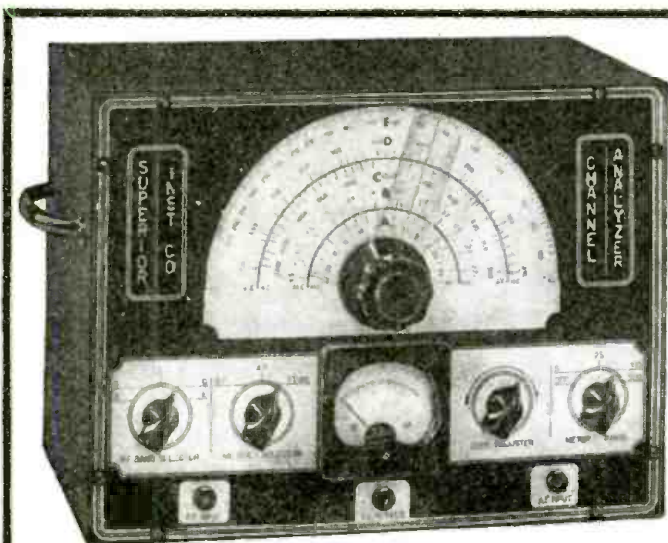

THE NEW CHANNEL-ANALYZER

Follows Signal from Antenna to Speaker of Any Set

THE CHANNEL-ANALYZER WILL—

1. Follow signal from antenna to speaker through all stages of any receiver ever made.
2. Instantly track down exact cause of intermittent operation.
3. Measure both Automatic-Volume-Control and Automatic-Frequency-Control voltages and circuits without appreciably loading the circuit, using built-in highly sensitive Vacuum-Tube Voltmeter.
4. Check exact gain of every individual stage in receiver.
5. Track down and locate cause of distortion in R.F., I.F., and A.F. amplifier.
6. Check exact operating voltage of each tube.
7. Locate leaky condensers and all high-resistance shorts, also show opens.
8. Measure exact frequencies, amount of drift and comparative output of oscillators in superhets.
9. Track down exact cause of noise.

Fundamentally, what the Superior Channel-Analyzer does is to permit the serviceman to follow the SIGNAL from antenna to speaker through each and every stage of any set ever made, and inferentially, of any set that ever will be made, using the SIGNAL as the basis of measurements. Thus if there is trouble in one particular channel or stage of a receiver, the serviceman can isolate the faulty stage and then proceed to ascertain the very part or component that causes the trouble.

Many of the troubles in modern receivers are due to the Automatic-Volume-Control and Automatic-Frequency-Control circuits and ordinary instruments do not permit measurements directly upon these circuits, so the Superior Channel-Analyzer includes a direct-current Vacuum-Tube Voltmeter that DOES make these measurements directly and with a negligible loading of the measured circuits.

Other problems cease to be problems too, when the quick-solution method of the Channel-Analyzer is applied. For instance, suppose a local oscillator in a superheterodyne drifts. The Channel-Analyzer has a switch operated, tuned input circuit with amplifier, whereby not only the presence of drift may be discovered, but also the amount and direction of drift.

Distortion is another difficulty that often nettles a serviceman. The Channel-Analyzer has a jack for the insertion of earphones so that you can listen to the signal directly from any stage and, therefore, discover the stage in which the distortion takes place. Next, the VTVM is used to discover the very component in that circuit that is causing the trouble. How often have you cherished the hope that someday you would own an instrument that enables you to measure the actual signal voltage across the load of any stage in the set, and thus by comparison determine the gain per stage. The Channel-Analyzer enables those dynamic voltage measurements and does a whole assortment of other work besides, yet

The Superior Channel-Analyzer comes housed in shielded cabinet and features an attractive etched aluminum panel. Supplied complete with tubes, three specially engineered shielded input cables, each identified as to its purpose. Also full operating instructions. Size 13"x10"x6". Shipping weight 19 pounds. Only

at a price much less than that usually asked for a dynamic voltmeter alone.

D.C. Voltages have important bearings on receiver performance. All these voltages can be measured on the Channel-Analyzer with the receiver in reproducing operation. In fact, that one important consideration, MEASUREMENTS WITHOUT MOLESTATION OF THE RECEIVER, gets rid of the drawback of most conventional equipment which greatly reduces the very voltage it attempts to measure, or kills the signal completely.

Tubes that are used in the receiver under test are also given a thorough check by the Channel-Analyzer and as such a specialized tube tester, this new and remarkable instrument is proof against any possibility of obsolescence.

Noise, another serious problem to servicemen, can be located with the aid of the Channel-Analyzer and can be done with incredible speed. Here are the basic components of the Channel-Analyzer:

1. B Supply rectifier and filter circuit.
2. One-stage, high-gain flat amplifier and linear diode detector.
3. Tuned-circuit, high-gain amplifier and linear diode detector, 100 KC. to 20 MC.
4. D.C. Vacuum-Tube Voltmeter, for measuring the rectifier R.F., I.F. or A.F., and for independent use on external circuits, all by front panel switching.

By adroit engineering and skillful application of a wide knowledge of servicing requirements based on Superior's years of experience, the four components listed above are made to do so many things and do them so well and fast that a large benefit is bestowed on servicemen, their tasks lightened, their work speeded and their experience greatly extended, all at record-breaking low price.

\$19⁷⁵

THE X-RAYOMETER FEATURES NEW

GIANT 9 INCH METER—AND A BUILT-IN POWER SUPPLY ENABLES RESISTANCE MEASUREMENTS UP TO 30 MEGOHMS

SPECIFICATIONS
RESISTANCE MEASUREMENTS IN 3 RANGES: 0-1000 Ohms, 0-100,000 Ohms, 0-30 Megohms.
D.C. VOLTAGE MEASUREMENTS IN 5 RANGES: 0-50, 0-250, 0-500, 0-1000, 0-2500 Volts. Television and other high voltage power supply circuits easily measured.
A.C. VOLTAGE MEASUREMENTS IN 4 RANGES: 0-50, 0-250, 0-500, 0-1000 Volts.
D.C. CURRENT MEASUREMENTS IN 6 RANGES: 0-1 Ma., 0-50 Ma., 0-250 Ma., 0-1 Ampere, 0-10 Amperes, 0-25 Amperes. High current ranges suitable for automotive and industrial work.
CAPACITY DIRECTLY READ ON METER SCALE IN 2 RANGES: .005-1 Mfd., .2 Mfd.-50 Mfd.
PERCENTAGE OF LEAKAGE of electrolytics read DIRECTLY on meter scale. Actual condition of condenser quickly determined.
INSULATION, INTER-ELEMENT AND A.C. LEAKAGES directly read on meter scale up to 30 Megohms.
OUTPUT MEASUREMENTS IN 4 RANGES: 0-50, 0-250, 0-500, 0-1000 Volts. Built-in blocking condensers enable rapid alignment of radio equipment.
INDUCTANCE MEASUREMENTS IN 2 RANGES: 0-7 Henries, 7-703 Henries.
DESI-BEL MEASUREMENTS IN 3 RANGES: D.B. based on 6 M.W. at 500 Ohms. -10 to +29, -10 to +43, -10 to +49. Audio frequency measurements in both radio and P.A. amplifiers.

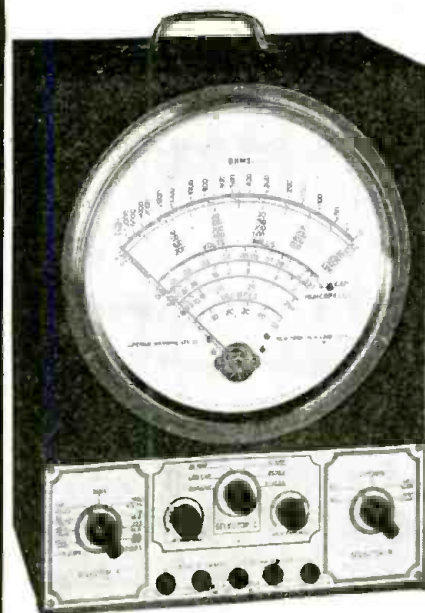

X-RAYOMETER comes housed in a new army gray crystalline, heavy gauge cabinet. Complete with test leads, instructions and tabular data. Shipping weight 20 pounds.

\$17⁹⁵
ONLY

THE NEW MODEL 1130-S SIGNAL GENERATOR WITH AUDIO FREQUENCIES

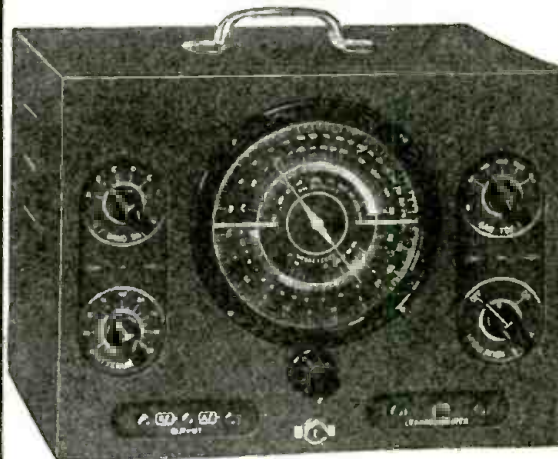

SPECIFICATIONS
 1. Combination R.F. and Audio Signal Generator. R.F. 100 kc. to 100 mc. A.F.—100-7500 cycles. All direct readings, all by front panel switching.
 2. R.F. and A.F. output independently obtainable alone or with A.F. (any frequency) Modulating R.F.
 3. Accuracy is within 1% on I.F. and Broadcast bands; 2% on higher frequencies.
 4. Audio frequencies in 5 bands: 100, 400, 1000, 5000, and 7500 cycles.
 5. Giant airplane full vision, direct-reading dial.
 6. Condenser and other leakages tested to 100 megohms.
 7. All services on 90-130 volts A.C. or D.C. (any frequency).
 Model 1130-S comes complete with tubes, test leads, carrying handle and instructions. Size 12"x9"x6 1/2". Shipping weight 15 lbs. Our net price

\$11⁸⁵

SUPERIOR INSTRUMENTS CO. 136 LIBERTY STREET, RC-11 NEW YORK, N. Y.

Please Say That You Saw It in RADIO-CRAFT

AUDEL'S NEW RADIO MANS GUIDE THE KEY

FOR HOME STUDY

TO WHAT EVERY RADIOMAN SHOULD KNOW JUST PUBLISHED—1939

—All the latest information on the new developments in Radio & Television. Explains Repairs, Servicing & Building of Sets for pleasure or profit —Easy to read & understand. Gives all the important phases of Modern Radio, Electricity & Sound. Ready reference guide. A real Helpful, Easy Way to secure authentic data on Radio Troubles—Static Elimination—Broadcasting—Antennas—Electronic Television—Repairs—Service—Short Wave—Auto Radio—Including Questions and Answers—34 chapters—772 Pages. Over 400 Diagrams & Illustrations. Handy Size. Sturdy Flexible Binding. A Good Investment for Servicemen—Experimenters—Electronic Television Students—Aviation & Marine Radio Operators and all others. Get this practical information in handy form for yourself. Fill in and mail coupon today.

4 COMPLETE • PAY ONLY \$1 A MO.

THEO. AUDEL & CO., 49 West 23rd Street, New York
 Mail AUDEL'S NEW RADIOMANS GUIDE for free examination. If O. K., I will send you \$1 in 7 days; then remit \$1 monthly until price of \$4 is paid. Otherwise, I will return it.

Name _____
 Address _____
 Occupation _____
 Reference _____ R.C.F.

THE LATEST RADIO EQUIPMENT

(Continued from page 296)

30-STEP ATTENUATOR

International Resistance Co.
 401 North Broad St., Philadelphia, Pa.

THIS new stud-type attenuator, known as the type B-31, is especially suited for low-level work. Bridged-"T", ladder or potentiometer networks are available. Standard attenuation is linear for 24 steps, 1.5 db. per step up to 36 db.; tapering off to 65 db. on the next to last, and to infinity on the last step. (Other values if desired.) The bridged-"T" circuit has constant impedance looking "in" and "out". Standard impedances for the bridged-"T" and ladder networks are 50, 200, 250 and 500 ohms, with other values being supplied on request.

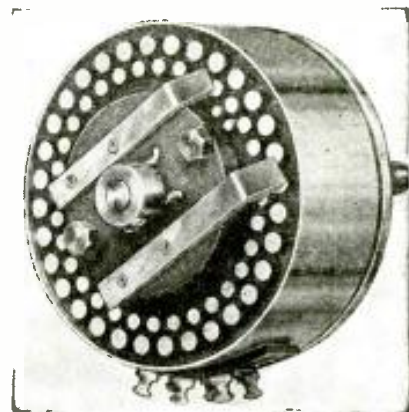

Resistors used are wire-wound for low-impedance circuits, and metallized resistors for high-impedance circuits. Removable aluminum cover affords protection against dust and dirt. Unit is 2 ins. x 2 3/4 ins. dia.

November 1939 Radio-Craft

"ELBOW" CONE PROJECTOR

University Laboratories
 195 Chrystie Street, New York, N. Y.

THIS cone projector is designed to utilize the acoustic output of both sides of the cone speaker, i.e., double the efficiency and coverage of the ordinary projector is obtained. One cone speaker, claims the manufacturer, gives the effect of 2.

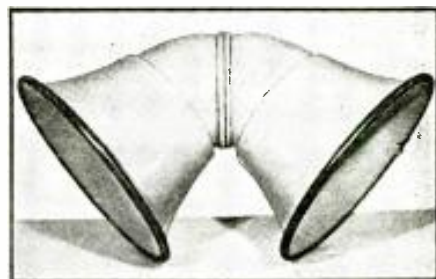

November 1939 Radio-Craft

EXTRA! BARGAIN BULLETIN

BIG MONEY SAVING CATALOG

Just off the press

Hundreds of items at New Low Prices. Radios, Sporting Goods, Jewelry, Electrical Appliances, Furniture, Luggage, Typewriters, Binoculars, Silverware, Gifts, Novelties, etc.

MAIL THIS COUPON FOR FREE CATALOG

RADIO CIRCULAR CO.
 915 Broadway, New York, N. Y.
 Rush Free Copy of BARGAIN BULLETIN. No obligation.

Name _____
 Address _____
 City _____ State _____

IF You are an experienced radioman;
 You are ambitious to get ahead rapidly in radio;
 You realize the necessity of a directed training in the engineering principles of radio but are unable to take advantage of college training,—

Then - - Send for our new illustrated book "A Tested Plan." It will give you complete details of an advanced home study course in Practical Radio and Television Engineering written for the experienced radioman.

CAPITOL RADIO ENGINEERING INSTITUTE
 3224-16th St. N. W., Dept. RC-11, Washington, D. C.

GET A BEAUTIFUL DESK LAMP ABSOLUTELY FREE!

Complete details as to how it is possible to get a Beautiful DESK LAMP FREE, appears on Page 314 of this issue. TURN TO IT NOW!

JOIN OUR RECORD CLUB

Send for your copy of this big 500 page Record Catalog & Encyclopedia. Contains lists of thousands of famous records and musical data on pronunciations and dates of composers; 25¢ plus 10¢ for mailing. (stamps or coin) It also entitles you in our Record Club. We carry a large selection of records from 10¢ up. Write today.

MODELL'S Dept. 58 Cortlandt St. 301 New York City

NEW FREQUENCY STANDARD

The Hallicrafters, 2611 S. Indiana, Chicago, Ill.



THIS new, model HT-7 instrument, is a crystal-controlled oscillator which will accurately serve many of the purposes of frequency meters and service oscillators.

Fundamental outputs at 1,000, 100 and 10 kc. are provided, each with harmonics made useful even in the highest frequency ranges by a built-in, tunable harmonic amplifier stage.

A dual-type 1,000-100 kc. crystal controls the outputs at these frequencies. The 100-kc. crystal position also locks-in a multivibrator which provides the 10-kc. output. Precise accuracy of the 100-kc. output (and therefore the multi-vibrator 10-kc. output) is assured by provision for slightly varying its frequency to exactly resonate, at its fundamental or a harmonic, with other standards such as WWV's transmissions.

Exactness to a fraction of 1 cycle is thus obtainable. The 10-kc. harmonics are strong enough to provide useful check points to well over 15 megacycles; and the 100- and 1,000-kc. harmonics, well beyond 30 mc.

The entire unit is enclosed in a steel cabinet 8 x 7 1/2 x 5 1/2 ins., finished in gray stipple. Four tubes serve as crystal oscillator, multivibrator, harmonic amplifier and power-supply rectifier. Panel controls: Fundamental-Frequency Selector Switch, 100-kc. Crystal Tuning, Harmonic Amplifier Band switch, Harmonic Amplifier Tuning, and On-Off switch.

November 1939 Radio-Craft

NEW "SUPER-PRO" RECEIVER

The Hammarlund Mfg. Co.
 424 West 33 St., New York, N. Y.

THE NEW Super-Pro is available in 2 tuning ranges, 15 to 560 meters and 7 1/2 to 240 meters. This latest addition to the world-famous family of Hammarlund Super-Pros incorporates a number of improvements including new variable-selectivity crystal filter, new and improved noise limiter circuit, and an entirely new "S"-meter arrangement. The new instrument is an 18-tube job and, in addition to providing the improvements mentioned above, continues to incorporate all the features of its predecessors.



November 1939 Radio-Craft

Please Say That You Saw It in RADIO-CRAFT

100-1,000 KC. OSCILLATOR STANDARD

Browning Laboratories, Inc. 750 Main St., Winchester, Mass.



ILLUSTRATED here is a new 100-1,000 kc., type BL-2FS oscillator standard. Servicemen and experimenters can build their oscillators around this basic unit. Stability of a high order is claimed through a judicious choice of components and careful electrical design. Adjustments are provided so that circuit capacities may be taken into account, and so each oscillator may be set to zero-beat with WWV. Adjustments for the 100 and 1,000 kc. oscillators are absolutely independent. A switch (integral with the apparatus) chooses either the 100 or 1,000 kc. at will.

November 1939 Radio-Craft

BASIC RECORDING MECHANISM

The Speak-O-Phone Recording & Equipment Co. 23 West 60 St., New York, N. Y.

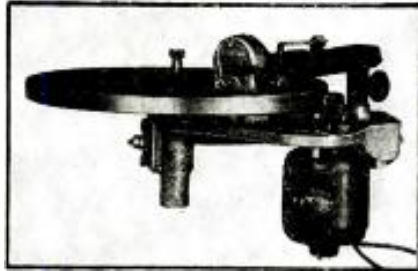

A GOOD-QUALITY A.F. amplifier is all that is necessary to make the basic recording equipment a first-class recording system! Apparatus consists of a rim-driven turntable energized by a General Electric constant-speed motor mounted directly on an aluminum casting. Driving torque is adjustable, and tracking is accomplished through a dual worm and flat gearing assembly. Claimed to be vibration-free, and absolutely minus backlash or bumps. Adjustable cutting

arm permits recording on acetate aluminum or pre-grooved discs without any additional equipment. Impedance of cutting head is 15 ohms.

November 1939 Radio-Craft

BOOK REVIEWS

AUDEL'S NEW RADIOMANS GUIDE, by E. P. Anderson (1939). Published by Theo. Audel & Co. Size, 5 x 6 1/2 ins., flexible cloth cover, 400 illustrations, 756 pgs. Price, \$4.00.

Audel's books for the radio man date back 10 years. Newest addition to the Audel library is this handbook, for the radio man and student, which covers the fields of land, air and marine radio, television, public address, and modern servicing. A section of the Guide devoted to basic fundamentals provides the necessary background for covering the more advanced material. A series of review questions and their answers tests the reader's progress. The subject of the receivers is built up from component circuits to the complete diagram. Testing methods and equipment are described, and diagrams of modern test instruments are shown. A series of radio troubles and their cures provide valuable pointers for Servicemen.

Prepared somewhat along the lines of engineering handbooks, it has 31 chapters; of special interest to Servicemen is Chapter No. 33, "Underwriters Standards." A valuable 11-page "Ready Reference Index" is included.

WIRELESS SERVICING MANUAL, by W. T. Cocking (4th Edition, revised, 1938). Published by Hiffe & Sons Ltd., London, England. Size 5 x 7 1/2 ins., cloth cover, 279 pgs., over 100 illustrations. Price 5/5 post (approx., \$1.50).

It is because servicing fundamentals are the same in any language that "Wireless Servicing Manual," an English book, is of interest to every radio Serviceman. Since only a slight portion of this book deals with specific makes of equipment the major portion will be of value to radio ("wireless") Servicemen everywhere.

This 4th Edition has been enlarged by the addition of 50 pages of new matter. An extra chapter deals with the subject of television receivers, and the appendices have been extended to include instructions for building a resistance and capacity testing bridge, and a tube testing bridge.

This handbook covers the principles and practice of the repair and adjustment of radio receivers. Methods of fault finding are dealt with in detail, the use of the necessary test apparatus is described, and ganging procedure is very fully treated.

PRACTICAL RADIO MATHEMATICS, by M. N. Beltman. Published by Supreme Publications. Size 8 1/2 x 11 ins., paper covers, 17 pages, illustrated. Price, 50c.

"Practical Radio Mathematics" will put on

the shelf of the radio Serviceman a handy reference to all the ordinary, elementary mathematics required in the general run of radio service work. This booklet is an off-set job, and for its type of make-up is quite well illustrated.

These chapter headings indicate the ground covered: Numbers, Fractions, Decimals, Simple Formulas Explained as a Tool; Units, How Subdivided, Color Code, Meter Scales and Accuracy; Ohm's Law, Radio Examples, Graphs, Introduction to A.C., Ohmmeter; Condensers, Formulas, Applications, Examples; Inductance, Air and Iron; Reactance, Impedance, Combined Circuits, Transformers; Vacuum Tubes, Voltage and Power Amplification, Output Coupling; Point-to-Point Testing, Volt-Ohm-Milliammeter Method; The Decibel, Defined, Handy Table, Examples.

A Few of the Feature Articles in the November issue of

RADIO & TELEVISION

How to Listen to Radio War News—Lowell Thomas, famous NBC commentator.

Radio and Television in War—illustrated—H. W. Secor.

A DeLuxe Portable Transmitter and Receiver—Howard Earp, W7CHT.

Latest Television Set Construction Data.

Up-to-date Short Wave Station List—Map shows where European War News originates.

New "Practical Radio Ideas" Department Hints for Set Constructors.

A 2-Tube Receiver for the Short Wave Fan—Harry D. Hooton, W8KPX.

Question Box

This 188 Page Money Saving 1940 Catalog **FREE**

on everything you buy!
COMPLETE STOCK OF PARTS
 Including items out of manufacture. All the nationally advertised brands. The world's greatest stock of parts. Consult your Lafayette catalog—save time and money.
COMPLETE IN TEST EQUIPMENT
 All the leading makes, all latest types. Every instrument accurately described. Here's the book that will enable you to keep up-to-date economically!
COMPLETE P. A. SELECTION
 Three complete lines — DeLuxe, Standard and Economy — for every purse and purpose. All systems — permanent, portable and mobile have the advantage of Lafayette advanced engineering. Amplifiers from 5 to 100 watts.
COMPLETE LINE OF RADIOS
 All the wanted features in portable, mantle, and phono-combination models. Beautiful style. Brilliant performance. Challenging the field in quality and low price.
COMPLETE HAM SECTION
 Greatest array of amateur receivers, transmitters, ham equipment we've ever assembled. Over 30 pages packed with merchandise—every item packed with value!
PLUS A COMPLETE
 line of 1940 auto radios, record players, tubes, tools, new books—all at lowest prices. Save money with the book that has everything in radio! Send for a copy today. It's packed with profits. And it's **FREE! Mail coupon now.**
 Radio Wire Television Inc. formerly WHOLESALE RADIO SERVICE, INC.
LAFAYETTE RADIO
 Radio Wire Television Inc. Dept. 319—100 Sixth Ave., New York, N. Y. Rush FREE 1940 Radio Catalog No. 78
 Name.....
 Address.....
 City..... State.....
 PASTE COUPON ON PENNY POSTCARD

Please Say That You Saw It in RADIO-CRAFT



NEW AND IMPROVED "Super-Pro"

HAMMARLUND'S new "SUPER-PRO" is the last word in communications receiver design. Its outstanding features include improved noise limiter; variable selectivity crystal filter; sensitive, adjustable "S" meter; two stages of tuned R.F.; three stages of I.F. amplification, and many others such as beat oscillator; A.V.C.; band spread, etc. The new "Super-Pro" has exceptional sensitivity and a high signal-to-noise ratio. This 18-tube receiver has a beautiful metal cabinet and is available in two tuning ranges, 7½ to 240 meters and 15 to 560 meters.

Mail coupon today!

HAMMARLUND MFG. CO., RC-11
424 West 33rd St., N. Y. City
Send for "Super-Pro" folder.

Name



Address

City State

HAMMARLUND

Canadian Office: 41 West Ave. No., Hamilton, Ontario

DATAPRINTS



TESLA-LOUDIN HI-FREQ. COILS

20c Ea. in order for 10
(Data and Drawings only.)
36" Sp'k Tesla-Oudin Coil 40c
(1 K.W. Exc. Trf. Data, included FREE!)

8" Sp'k Tesla-Oudin Coil 40c
(¼ K.W. Exc. Trf. Data, included FREE!)

3" Sp'k Oudin; 110 Vt.
"Kick Coil" type.....40c

3" Sp'k Tesla Works on
Ford Sp'k Coil.....40c

1" Sp'k Violetta Hi-Freq. Coil.....40c

FREE with order \$1.00 or more—20 Tricks with Hi-Freq. Coils (40c separate)



Induction PIPE & ORE LOCATOR

(Construction Data40c)

YOU need these DATAPRINTS!

5 Meter Superhet.	Resistance Measuring
½ Meter Tr. & Rec.	Bridge
20 A.C. Probs. & Ans.	Weld. Transf. 2 K.W.
20 Telephone Hook-ups	Rewinding Armatures
100 Mech. Movements	String Galvanometer
20 Motor Hook-ups	20 Simple Bell Circuits

Special Prices: 4 prints \$1.00; 10 for \$2.00;
Single, 40c each. Get New Catalog 100 A.

The DATAPRINT Co.

Lock Box 322C, Ramsey, N. J.

EVERYTHING IN RADIO!

A COMPLETE SOURCE FOR YOUR RADIO NEEDS
Our immense stock of radio sets, parts and supplies enables you to purchase your entire needs on one order. You will find all your Nationally Known Favorites in this big book which is FREE for the asking. Practically every order is shipped the same day it is received.
WRITE FOR BIG NEW CATALOG

BURSTEIN-APPLEBEE CO.
1012-14 McGee St. + Kansas City, Mo.

THE RADIO MONTH IN REVIEW

(Continued from page 263)

Last month RCA installed sound amplification and distribution systems in these edifices to augment the effectiveness of their services and musical presentations. Gold-finished microphones were used on the altars. A 50-W. amplifier with 6 microphones and 4 loudspeakers was used in the Cathedral of St. John the Divine; more terminal equipment will be added. Two 30-W. jobs were installed in St. Patrick's Cathedral together with 12 microphones and 18 loudspeakers to complete an existing sound installation.

Radio men who plan to sell radio installations to hospitals in South Carolina, even though such installations admittedly may aid greatly in effecting cures, must watch their P's and Q's. A radio law enacted in S.C. last month makes it a misdemeanor, punishable by a fine of \$100 or imprisonment up to 30 days, "for any person to operate any radio or other musical instrument in such a manner that it annoys or disturbs any patient confined to a hospital or sanitarium." General equipment in most hospitals, asylums and sanitariums today have radio facilities, including earphone attachments or built-in radio pillows, either for diversion or treatment of patients.

The brothers Freese, William and Rudolph, make kite flying their hobby. Last month they sprang a new one on Breezy Point near "the Rockaways," New York. A dummy carried aloft at least wasn't speechless for it contained a loudspeaker!

The press item by John Chapman in his "Mainly about Manhattan" column in the *New York Daily News*, did not state whether the associated amplifier too was carried aloft or whether a transmission line was used between ground and kite—and the Freeses "won't talk."

Talkies Servicemen had made available to them last month, by the Academy Research Council, a number of test reels designed for use in adjusting theatre sound reproducing equipment.

The Theatre Sound Test Reel contains sound and picture, the sound consisting of dialogue and music recordings so chosen that the assembled reel contains a representative example of sound as currently recorded by each sound department. One of these recordings is a hi-range print which serves as a check on the amplifier capacity in relationship to the volume of the auditorium. The 1,000-ft. reel also contains about 100 ft. of "piano" and 12 ft. of "3,000-cycle" recording for making critical tests of flutter.

Other films include Standard Multi-frequency Test Reels, Standard Buzz (lateral alignment) Track, Standard Scanning Illumination Test Track, Standard 7,000-cycle Film, Standard 9,000-Cycle Film, Rear Scanning Adjustment Track, and Standard Balancing Film.

The RCA sound system installed in the \$11,000,000 Union Passenger Terminal, Los Angeles, was credited last month with playing an important part in achieving the record for efficient service and comfort which has been established in the short time the terminal has been in use. RCA Installation In New Union Terminal Also Entertains Waiting Travelers. Largest ever to be placed in a railroad station in the United States, this sound system

has played a major role in handling the hundreds of thousands of visitors who have poured through the Terminal.

The Union Pacific, Southern Pacific and Santa Fe railroads, combined ideas and resources to make the Los Angeles Terminal the most up-to-date and beautiful structure of its kind in the country. Its special, elaborate sound system, which through providing instant communication in every part of the acoustically-treated structure, affords travelers many new comforts and conveniences.

It carries announcements of the arrival and departure of trains, recorded music for those who rest in the Terminal's Garden Patios or in the comfortable over-stuffed seats in the spacious Main Waiting Room, and radio programs for entertainment and relaxation. The system is also equipped with complete broadcast pick-up facilities at various locations for special events.

"Nerve center" of this complex communication network is a custom-built console control unit which is located in a specially-designed control room. The console also contains an automatic RCA Victrola and radio receiver. With it a single operator can route all train announcements and special programs to any or all sections of the building over a 2-channel system. Two-channel distribution permits broadcasts of announcements in one part of the station with simultaneous programs of recorded music for the Restaurant and Rest Rooms.

The Main Concourse, the Main Waiting Room and the North and South Patios are equipped with powerful 2-unit loudspeakers which provide high-quality reproduction of music or speech over a range of 30 to 10,000 cycles. The speakers are mounted behind attractive grilles in wall plaques or concealed behind entrance grilles. (See photos, pg. 263.)

The system includes a bank of five 50-watt amplifiers, each supplying a 2-unit speaker or a group of smaller speakers which are located conveniently in the station's Ultra-Modern Restaurant, in the Rest Rooms, and on the Train Platforms.

TELE-FILMS

Flickerless tele-film transmissions can be made by combining the high-retentivity or accumulator-image cathode-ray television pick-up tube with the Mechau film projector, according to Schroter and Urtel of Telefunken (Berlin, Germany). A photo of this composite mechanism was received by *Radio-Craft* last month and is shown on pg. 263.

The film feed of the Mechau projector is continuous. Ordinarily, therefore, the resulting image-frames would be moving across the screen continuously. However, by placing in the projection plane a drum or ring of mirrors, and simultaneously revolving and oscillating these mirrors, the images may be made to appear successively stationary. The ring of mirrors is rigidly coupled to the film drive, and serves to superimpose one complete image upon another successively. The first image gradually decreases in intensity while the second is increasing in intensity, and thus, the first image dissolves into the second.

Since this action takes place uniformly over the entire area of the image it is possible to electronically scan each frame without relation to either the time or the frequency of the image change. In other words, it is possible, for example, to run the film at about 24 frames per second while scanning at 25 frames per second.

Please Say That You Saw It in RADIO-CRAFT

CONDENSERS— MINUS GUESSWORK

(Continued from page 281)

teristics which are of importance. In certain condenser ("capacitor" or refrigerator) applications, for instance, power factor may be of importance. If a condenser under measurement has a high power factor it will be indicated by failure of the indicator eye to open all the way when the balance adjustment is made.

In some applications in radio and power circuits relatively high power factors can be tolerated. This is true of many applications when electrolytic condensers are employed. In the case of wet electrolytics and low-voltage dry electrolytic condensers (or refrigerator-motor "capacitors") satisfactory service may be provided even though only a partial indication of balance is obtainable on the bridge. In general it is safe to say that if a condenser under test gives a definite balance indication it will provide satisfactory service even though the eye may not open all the way at this balance point. If an electrolytic condenser fails to give any balance indication it should be aged at rated voltage and again tested.

Intermittents.—Intermittent defects in condensers are more than likely to show up when tested in this bridge because of the low applied A.C. voltage. Such a defect may be indicated by either a SHORT or OPEN reading, or by a shifting balance point when a reading is attempted.

CAPACITY TOLERANCE

In checking condensers of all types it should be borne in mind that rather wide tolerance is permissible so far as actual capacity values are concerned. Except in tuned circuits and in a few of the more critical types of bypass circuits, a condenser within 30 per cent of the specified value will be satisfactory. On the "high" side they may vary much more than this in most applications but if a condenser is more than 30 per cent below specified value it generally should be replaced. In most tuned circuit applications, time delay circuits and critical bypass circuits 10 per cent tolerance is considered permissible and there are extremely few applications where a value of 10 per cent above or below rating will materially affect operating results.

In measuring small capacity values up to about 200 mmf. it is best to plug the actual condenser leads directly into the tip-jacks of the bridge. Test leads a couple of feet long may contribute an appreciable amount of capacity—and this value may vary considerably as the leads are moved about. Where it is necessary to use test leads their capacity alone should first be measured and this value deducted from the reading obtained when the condenser under test is measured. Where values in excess of 200 mmf. are involved the capacity contributed by test leads may be neglected.

It is believed that the little instrument described here will prove to be a highly practical contribution to the growing list of modern service equipment; and further, that it will fill a long felt need on the part of the laboratory technician and experimenter for a convenient and compact device capable of providing the most commonly needed information on individual condensers.

This article has been prepared from data supplied by courtesy of Cornell-Dubilier Electric Corp.

CORRECTION: The 8th prize of the 2nd group of prize winners in our P.A. Contest was donated by the Amplifier Co. of America, not by Amperite Company as shown on page 204, October Radio-Craft. Amperite donated the 7th prize.

NO OTHER TESTER OFFERS

All THESE FEATURES

SUPREME 504 TUBE and SET TESTER

Gives You Everything!



- Complete, modern tube tester, set tester, and condenser analyzer in one compact instrument.
- "Arrow-Way" tube testing, using fast roller chart. A number appears under each arrow-way. Set controls from left to right—just "follow the arrows."
- Correctly tests all tubes—including "7," "1A," "35," "50," "70," "85," "117," "S" (single end tubes) series, loctals, octals, non-octals, "G," "MG," "M," "GT" types, gaseous rectifiers, magic eyes, ballast tubes, pilot lights.
- Tests tubes 7 ways (1) open filaments, (2) "hot" leakage cathode test, (3) super-sensitive "hot" anode leakage test, (4) shorts, (5) opens, (6) overall quality, (7) separate section and plate quality test. Only a GOOD tube will pass.
- Tests made at proper applied anode voltages and rated load for all tube types.
- Only six sockets required for all present and future tubes. No additional instructions necessary on the tube chart. You CAN'T place a tube in the wrong socket.
- Patented SUPREME "double floating" Filament Return Selector Push Button System banishes obsolescence. Let filament positions on future tubes change to any possible arrangement—to take care of such changes all you do is PRESS A BUTTON.
- Only Supreme has the FILAMENT VARI-VOLT SELECTOR circuit. Regardless of what present or future tubes may be—1.4 to FULL LINE VOLTAGE—the vari-volt selector will supply the CORRECT heater and filament voltages.
- "Speed-Way" push button multimeter circuit. Two rows of push buttons control 31 basic ranges and functions.
- 0.1 TO 2500 D.C. VOLTS—7 ranges of 0/5/25/100/250/500/1000/2500.
- 0.1 TO 1000 A.C. VOLTS—5 ranges of 0/5/10/50/250/1000.
- 10 MICROAMPERES TO 10 AMPERES—7 ranges of 0/500 microamperes /2.5/10/50/250 milliamperes /1/10 amperes D.C.
- 0.1 TO 1000 OUTPUT VOLTS—No external condenser necessary. 5 ranges of 0/5/10/50/250/1000.
- 0.1 TO 20 MEGOHMS, 3.5 OHM CENTER SCALE—5 ranges of 0/200/2M/20M/2 Meg/20 Meg. Self-contained power supply.
- ALL electrostatic capacitors checked—direct reading—for leakage up to 20 megohms on meter.
- ALL electrolytics including high voltage filter capacitors and low voltage—high capacity bypass capacitors, checked at WORKING VOLTAGES.
- 7 individual working voltages of 450, 300, 250, 200, 100, 50 and 25 volts.
- Settings are given for each capacity and working voltage on roller chart and tests made on a "Good Capacitor-Bad Capacitor" English reading scale.
- All ranges except D.C. 2500 volt and 10 amps, operate from but one set of pin jacks.
- New "Perma-grad" temperature compensated A.C. voltmeter circuit with full rectifier protection. Rectifier guaranteed with instrument.
- 4" x 4 1/4" 500 microampere meter—oversize solid forged alnico magnet with welded pole pieces—a life-time meter.
- All multimeter ranges factory calibrated to within 2% on D.C. and 3% on A.C.
- Individually, specially selected and aged ceramic resistors used for all voltmeter ranges. Wire wound resistors in all current ranges.
- May be purchased on easy payments—just a few cents a day, no more than the cost of your cigarettes.

SUPREME

SUPREME INSTRUMENTS CORP.
GREENWOOD, MISSISSIPPI, U. S. A.

EXPORT DEPT. Associated Exporters Co., 145 W. 43rd Street, New York
Cable Address: SOPREK N. Y.

SUPREME INSTRUMENTS CORP., Dept. C-18
Greenwood, Miss.
Please RUSH me your nearest information on SUPREME 504 and other brand new 1940 Model SUPREME instrument.
Name _____
Address _____
City _____ State _____

GET A REAL ELECTROPLATING KIT ABSOLUTELY FREE!

Complete details as to how it is possible to get a Real Electroplating Kit FREE, appear on Page 319 of this issue. TURN TO IT NOW!



D9T
DYNAMIC



C6 CRYSTAL

DYNAMIC MICROPHONE D8

AMERICAN BUILT QUALITY INTO THE D8. List Price\$22.50

Also, adjustable yoke permits nondirectional or semidirectional pick-up.

Plug at microphone for quick cable attachment.

D8-T, 200 Ohm, 500 Ohm, or High Impedance \$25.00

Licensed by ERPI. Request Spec. Bulletin No. 33

AMERICAN MICROPHONE CO., Inc.
LOS ANGELES, CAL.



Please Say That You Saw It in RADIO-CRAFT

EXACT DUPLICATE Replacement Condensers

- There's one sure way to save money, time, trouble, when replacing worn-out condensers. That's by using AEROVOX Exact-Duplicate Replacement Condensers.
- Such matched units fit right, work right, look right. You install them—and forget them. No return calls "to make good".
- Ask local jobber for latest listings. Order a replacement for that set you're servicing.
- Or write us direct for data.

AEROVOX CORPORATION
NEW BEDFORD, MASS.
IN CANADA: AEROVOX CANADA Limited, Toronto, Ont.

EXTRA MONEY FOR YOU! **NOW ONLY 10¢**

CASH IN!

NEW 1940 EDITION
68 PAGES

MAIL ORDER PLANS TESTED MONEYMAKERS BUSINESS SECRETS SUCCESS SCHEMES

A MARVEL BOOK 40,000 WORDS in TEXT! In "CASH IN" you get ALL the real money-makers—dozens of profitable tested mail order plans, confidential business secrets, dozens of practical tested formulas, successful tested schemes—actual experiences of men who have started on a shoestring—with less than \$10 capital. Money-Back Guarantee.

"CASH IN" contains only tested ideas covering every type of full- or spare-time enterprise—it's a "masterpiece" in business ventures. 10 CENTS per copy. Sent POSTPAID anywhere upon receipt of 10 cents U.S. stamps or coin.

NATIONAL PLANS INSTITUTE
246-R FIFTH AVENUE NEW YORK, N. Y.

PATENTS—TRADE MARKS

Booklet concerning Inventions & Patents Form "Evidence of Conception" with instructions for use and "Schedule of Government and Attorneys Fees"—Free

LANCASTER, ALLWINE & ROMMEL
Registered Patent Attorneys
436 Bowen Bldg. Washington, D. C.

LES Correspondence Courses in RADIO and ELECTRICAL ENGINEERING

ELECTRICAL ENGINEERING Get good grasp of wide electrical field. Prepare yourself, at Low Cost, for secure future. Modern, simplified, you can understand quickly.

RADIO ENGINEERING Extra fine course in radio, publication address, photo-electric work. Trains you to be super-service man, real vacuum tube technician. Exper. kits furnished. Diploma on completion. Tuition, \$25. either course. Deferred payment plan. Get copies of school catalogs, student magazines, complete details, SEND NOW!

FREE

LINCOLN ENGINEERING SCHOOL, Box 931-C11. LINCOLN, NEBR

How to Add 1 to 14 Modern Features to the ALL-PUSH-PULL DIRECT-COUPLED 30-WATT P.A. AMPLIFIER

(Continued from page 269)

becomes possible to vary the expansion time from 0.05-second to 0.5-second (an overall time ratio of 100).

One of the additional important advantages obtained in using push-pull expansion is that full-wave rectification takes place at V2 and V4 after the expander amplifier V1 and V3 have amplified the incoming signal. This push-pull rectification cuts hash down considerably and enables the use of comparatively low values for R1, R2, R3 and R4 (filter resistors) which in turn provide for a wide range in time delay settings without the introduction of hash into the amplifier proper.

WHY USE A 30-WATT AMPLIFIER?

One of the most important contributing factors in the development of overload distortion in expander amplifiers is that when a predetermined degree of expansion is employed, insufficient attention is given to the clean power output rating of the amplifier. Few technicians realize that when 12 db. expansion is employed, in an amplifier delivering an average level of 1.5 watts, a total of 24 watts is developed at peak expansion. (A simple method of calculating this, is to remember that for every 3 db. the amplifier power is doubled; 12 db. progressively doubles the output 4 times from 1.5 watts to 3, 6, 12, and finally 24 watts. Likewise, if the original average signal is 2 watts, 12 db. expansion will bring it up to 32 watts!) Needless to say, a 10- or 20-watt amplifier will not properly handle this degree of expansion, and here lies the true reason why a 30-Watt Amplifier is not excessive for home use.

It has been the writer's experience to note a considerable degree of surprise when a 30-watt amplifier (with expansion) was recommended for home use. The usual astonished reply was, "What! 30 watts! I will drive all my neighbors out!" It is to be borne in mind, however, that the 30-watt level may only be maintained for a fraction of a second during the rendition of the entire recording. Furthermore, amplification of low frequencies at this high level, will not produce half the amount of the estimated disturbance. Of course, the amplifier need not always be operated at a 12 db. expansion setting, nor need it be operating at a 2-watt average.

OVERCOMING OVERLOAD DISTORTION

In order to overcome the possibility of overloading this amplifier under any operating condition, a loss circuit is incorporated in the plate circuits of the 6SK7's, which operate in conjunction with a D.P.D.T. switch Sw.1, Fig. 2, to introduce a loss of 12 db. As the amount of expansion will not exceed 12 db. when the expander switch is snapped into the circuit, at any predetermined level, 12 db. is automatically subtracted. It is therefore impossible to exceed the previous normal level at peak expansion. This type of circuit insures against overload distortion.

The objections of a single-channel system are completely overcome by the use of the push-pull expander circuit illustrated in Fig. 3. This type of a circuit completely cancels all even-order harmonics and makes available for the first time, a high-quality phono amplifier circuit. It will be noted that the usual 1612 pentode grid converter, or its more microphonic prototype the 6L7, is not employed, because of the high even-order harmonics introduced with this tube at comparatively low input level.

HIGH-FREQUENCY ACCENTUATION AND ATTENUATION CIRCUIT

The desirability of using frequency equalization cannot be disputed by any amplifier technician (unless, of course, the amplifier is to be used for some fixed laboratory setup). One of the most effective types of high-frequency equalizing circuits is illustrated in Fig. 4A.

In Fig. 4A, the resistor network, R1, R2, introduces a fixed loss into the grid circuit of V1, dependent upon the ratio of R2 to R2 + R1. If a 10 db. accentuation is desired at 10,000 cycles, the network is designed to produce a 12 db. loss at 1,000 cycles.

When the potentiometer, R2, is at the "boost" position, Fig. 4B results. Condenser C1 will then bypass resistor R1 and effectively shunt this resistor to a negligible value. This effect, however, will only take place at high frequencies, so that a slowly rising characteristic is obtained. By proper design, the rise can be started at 1,000 cycles. The slope of the degree of accentuation is dependent upon the setting of R2.

If, on the other hand, R2 is set for high-frequency attenuation, Fig. 4C results. Under this condition, the high frequencies

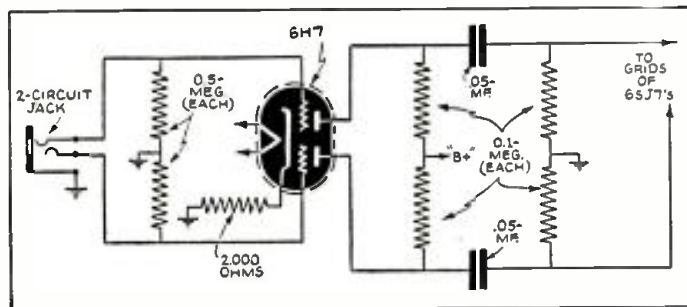

Fig. 9. Low-gain push-pull input. The tube is a type 6N7 (not a 6M7 as indicated).

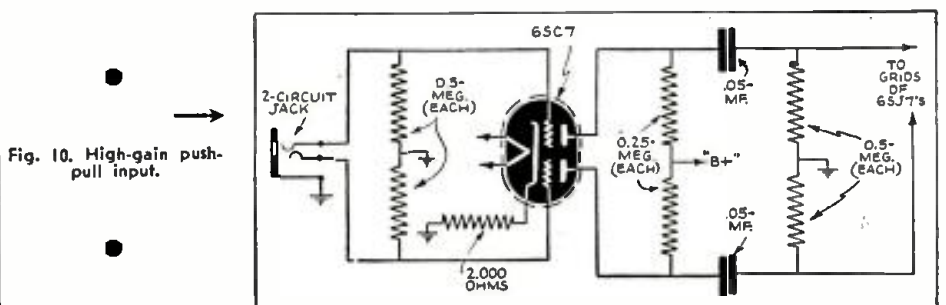

Fig. 10. High-gain push-pull input.

Please Say That You Saw It in RADIO-CRAFT

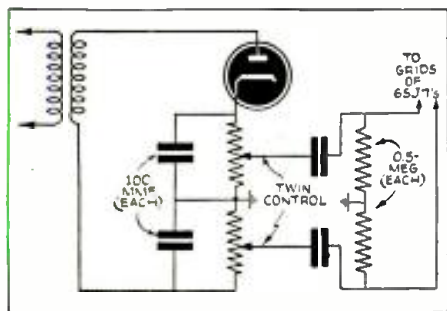

Fig. 11. Push-pull detector circuit.

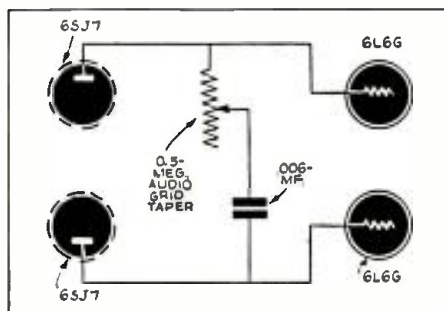

Fig. 12. Tone circuit for 10-W. direct-coupled amplifier.

are simply shunted. The slope of this attenuation circuit is likewise dependent upon the selection of the resistor and condenser values. An intermediate setting between 4A and 4B will result in a normal (straight line) response.

The adaptation of this circuit for push-pull operation is relatively simple. It merely involves the use of a twin volume control and duplicate set of resistors and condensers, as is illustrated in Fig. 4D. This type of tone circuit makes available, for the first time, a true push-pull high-frequency equalizing system.

THE LOW-FREQUENCY BOOST AND CUT CONTROL

No equalizing circuit can be considered really complete unless it provides for individual control of both the high and low frequencies. For ideal conditions, the design of this type of circuit should provide independent control of both the high and low frequencies, without any interaction. The most effective "mate" circuit for the high-frequency equalizer is basically illustrated in Fig. 5A.

It will be noted that this circuit is virtually identical to the high-frequency equalizer, with the exception that a choke (Ch.1), is used in place of the condenser, C1. As is well known, an ideal choke exhibits a diametrically opposite characteristic to frequency response when compared to a condenser. In other words, the impedance of a condenser increases with a decrease in frequency, and decreases with an increase in frequency. A choke, however, reacts in an opposite manner. That is, its impedance increases at high frequencies, and decreases at low frequencies. Based upon this well-known phenomenon, it can easily be noted, how Ch.1 boosts bass frequencies when R2 is set for maximum bass boost.

See Fig. 5B. Here Ch.1 effectively shunts resistor R2, but only at low frequencies. Therefore, the ratio of R2 to R2 + R1 changes to increase bass response.

When the control is set for bass cut, see Fig. 5C, the choke effectively shunts the output of the preceding circuit, but only at low frequencies. Naturally, this shunting effect is inversely proportional to frequency. That is, it is greater at lower frequencies.

The adaptation of this circuit to push-pull follows conventional procedure, and is illustrated in Fig. 5D.

A COMPLETE EQUALIZER CIRCUIT

By combining both of these basic circuits, a unique and highly effective push-pull individual high-frequency and low-frequency accentuating and attenuating circuit is made available. Inasmuch as both circuits are virtually identical, it becomes a relatively simple matter to combine them by merely using 2 twin controls, of such a value, so that their effective shunt resistance is equivalent to the value of R2. A completed tone-compensating circuit is illustrated in Fig. 6.

OPTIONAL LOW-GAIN SINGLE-ENDED INPUT

As many experimenters, technicians, and users of this type of an amplifier have expressed difficulty in obtaining a push-pull signal to be fed into the push-pull amplifier, a low-gain inverter tube, the 6N7, is provided as an optional input circuit. See Fig. 7.

It will be noted that this circuit follows conventional design with the exception that plate load resistors having very low values are used to insure quiet operation. This inverter circuit adds approximately 20 db. to the overall gain of the amplifier. With this particular circuit, it is possible to dispose of the twin volume control of the main amplifier and insert a standard audio grid taper control in the input grid circuit of the inverter tube.

OPTIONAL HIGH-GAIN SINGLE-ENDED INPUT

Where a gain of more than 100 db. is required, it is recommended that a high-gain single-ended input circuit be incorporated, as diagrammed in Fig. 8. This unit may take the place of the low-gain inverter (of Fig. 7) or it may be used as an auxiliary high-gain input.

It will be noted that in this inverter circuit, a 6SC7 is used with (comparatively) high-resistance plate loads, so as to insure maximum gain. Approximately 30 db. is added to the overall gain of the Direct-Coupled Amplifier, bringing its total up to 120 db. If both inverters are to be added, their outputs are simply paralleled. With such an arrangement, 2 individual single inputs are made available; one having a gain of 110 db. and the other of 120 db.

ADDITIONAL LOW-GAIN PUSH-PULL INPUT CIRCUIT

For some applications, it may be desirable to maintain the push-pull arrangement throughout the amplifier. This type of a circuit will require a twin triode unit. The 6N7 is admirably adapted for such use. The circuit follows conventional design as diagrammed in Fig. 9. It is to be borne in mind, that a 3-way plug should be used to bring the signal into the low-gain push-pull input. This circuit adds approximately 17 db. to the overall gain of the amplifier, making a total of 107 db.

ADDITIONAL HIGH-GAIN PUSH-PULL INPUT CIRCUIT

If both a higher gain and a push-pull input circuit are required, the 6SC7 may be used, with values as diagrammed in Fig. 10. This circuit adds approximately 27 db. to the overall gain of the amplifier, making an overall total of 117 db. available.

The following remaining features, which may be incorporated into this amplifier, will be completely described in the next issue: **Push-Pull Automatic Volume Compressor**

(Continued on page 304)

The ARCTURUS EQUIPMENT DEAL Puts It Into Your Shop at Almost No COST!

No matter what units you need to modernize your store and shop facilities, chances are you can obtain them easily and quickly merely by selling high-quality Arcturus Tubes!

The Arcturus Equipment Deal, with Lower Down Payments and Lower Tube Requirements than ever offered before, was devised by Arcturus to help you do more business at a greater profit. It enables you to offer your customers Radio's finest Tubes . . . it gives you your regular tube profit . . . and, best of all, it gives you an EXTRA PROFIT in the form of modern store and shop equipment! Tube prices remain Standard — less standard discounts

Mail the coupon today. Let us show you how you can increase your business, speed up service—make more money from now on!



ARCTURUS

ARCTURUS RADIO TUBE CO., Newark, N. J. C-24 Without cost or obligation, send my copy of the ARCTURUS DEALER HELPS Folder and details of the ARCTURUS EQUIPMENT DEAL.

Name.....
 Street.....
 City..... State.....
 I am a dealer I am a serviceman. My
 jobber is.....

For your convenience this coupon can be pasted on a penny postcard

Please Say That You Saw It in RADIO-CRAFT

Sound specialists are making money in P. A. with LAFAYETTE!



GET IN THIS PICTURE!
Today, owners of stadiums, ballrooms, churches, department stores, offices, garages are sold on the importance of Sound. New outlets for P.A. sales develop every day! You can sell these—and profit more—with the Lafayette line for 1940.

WE'VE GOT THE SYSTEM
for every purse and purpose. Allied, too, Lafayette offers three lines—a DeLuxe, Standard and Economy to help you quickly turn prospects into customers, stock into cash profit. For there's eye appeal in Lafayette's packaged P.A.—and performance that can't be matched even at twice the low Lafayette price.

HERE'S ALL YOU DO
Tear out coupon and mail for FREE catalog. See the world's most complete line of sound systems. Compare Lafayette feature for feature, dollar for dollar with any other P.A. Then, go to town with Lafayette—the money-making line in the low price field.

LAFAYETTE P. A.
NEW YORK, N. Y. • CHICAGO, ILL. • ATLANTA, GA.
100 SIXTH AVENUE, NEW YORK, N. Y. JACKSON BLVD., 314 PEACHTREE ST., BOSTON, MASS. • BRONX, N. Y. • NEWARK, N. J. • JAMAICA, L. I.

Rush FREE 1940 Radio Catalog No. 78.

Name.....
Address.....
City..... State.....

Radio Wire Television Inc. Formerly WHOLESALE RADIO SERVICE
Dept. 3LP9—100 Sixth Ave., New York, N. Y.

CONVERTING A 5-INCH TELLY KIT FOR RECEIVING A 9-INCH IMAGE

(Continued from page 264)

square tab on the condenser itself should be bent over and soldered to the mounting bracket. Bare pieces of hookup wire should be threaded through all the socket prongs which are shown grounded. Do this on all sockets.

reproducing greater detail, the I.F. band width shall be widened to pass 4 megacycles. This is done by adding 2 stages of I.F. and making proper realignment. Lastly, the larger Kinescopes require 7,000 volts for correct operation and since we already have 2,000

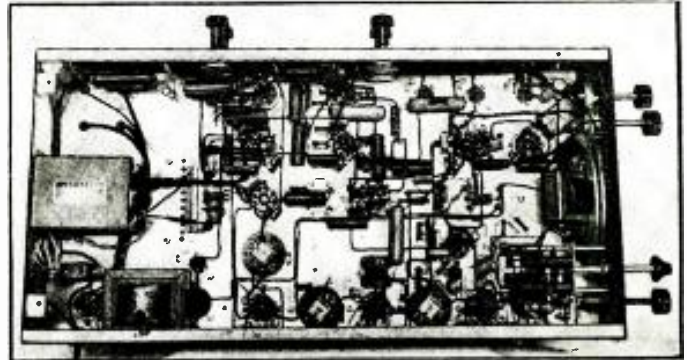

Good television reception depends in good measure on neat and sensible wiring of all components. This is an underchassis view of the completed 5" kit.

WIRING

Filament wiring is next on the program and should be done carefully as there are 2 windings on the transformer. The balance of the wiring should be done in the following sequence from antenna post to 2nd-detector of the image I.F. channel. Wire-up each socket completely, and keep each plate and grid lead 1/4-inch from the chassis and other wiring. Next, wire-up the Sound portion of the set completely except for the speaker. Third, wire-up the Sync. Pulse Separator circuit completely. Fourth, wire-up the Horizontal Sweep oscillator and amplifier complete. Fifth, do the same with the Vertical Sweep oscillator and amplifier. Sixth, wire up the Video amplifier and Kinescope socket, leaving some slack in the wiring so that the Kinescope may be turned without breaking connections. Mount and wire both power transformers and associated supplies completely except for the primary winding on the high-voltage transformer. Next, mount and wire the speaker; and lastly, mount the coil switch unit, wiring it carefully.

If you have checked each wire as it was put in, and each resistor was measured by ohmmeter and every winding on every transformer was checked for continuity before wiring up, then the final checkup will be that much easier to do.

Place all tubes except the Kinescope and 879 rectifier in their proper sockets, plug the receiver into the light socket and turn the set on. Check all operating voltages according to the table in the instruction sheet and allow a 10 per cent variation in readings. Greater variations indicate a defect somewhere in the circuit. If everything is OK the set is ready for alignment.

CHANGES TO USE 9-INCH C.-R. TUBE

Since this procedure is rather involved and requires a lengthy description, the reader would do well to follow the manufacturer's instructions implicitly. Later on, after the conversion is done, the alignment will have to be altered somewhat and a detailed description will be given. This requires only a shop signal generator and preferably a V.-T.V.M. although the usual output meter will suffice. If you have a service scope you can test both sweep circuits for waveform and amplitude. If not, the sweeps may be checked on the Kinescope screen separately or together. Both sweeps are designed for push-pull electrostatic deflection and since the larger Kinescopes employ only electromagnetic deflection the sweeps must be altered to suit. Further, since the larger Kinescopes are capable of

volts available in the receiver, a simple 5,000-volt supply is added in series with the existing equipment. The operation of the set after conversion will be essentially the same as for the standard set.

Since there is no room on the standard chassis for the additional parts and tubes required in the conversion, we will have to make 3 small chassis which can be assembled and wired as separate units, that is, I.F. Amplifier, Magnetic Sweeps, and Hi-Voltage Power Supply. These units will then be fastened to the left, right and rear of the main chassis.

The schematic circuit of the standard kit is shown in Fig. 1 so that a "before and after" comparison can be made later on.

A complete list of the parts required in the conversion will be given in Part II.

DIRECT-COUPLED 30-WATT AMPLIFIER

(Continued from page 303)

- Non-Frequency Discriminating Scratch Suppressor
- Audio Spectrum Control
- Push-Pull Automatic Volume Limiter
- Calibrated Volume Indicator
- Remote Control
- Push-Pull Automatic Volume Control

Addenda: Balanced Push-Pull Detector Circuit. A great many requests have been received for a suitable balanced push-pull detector circuit for use with the All-Push-Pull Direct-Coupled Amplifier. Such a circuit is given in Fig. 11.

It will be noted that the load resistor of the diode circuit is divided into 2 equal parts, and the center is grounded. This type of a circuit will deliver 2 signals, which are equal and exactly 180 degrees out of phase. The 2 resistors, of course, are equal sections of a twin volume control. It is important to note that each of the sections is individually filtered. This circuit has a distinct advantage in developing a balanced push-pull output signal under widely varying tube characteristics, because the output is automatically balanced as long as both sections of the twin volume control are of the same value.

The tone control circuit for the All-Push-Pull Direct-Coupled 10-Watt Amplifier, which appeared in the July, 1939 issue of *Radio-Craft*, page 16, was inadvertently omitted. This is now given in Fig. 12.

This article has been prepared from data supplied by courtesy of Amplifier Company of America.

NEW!

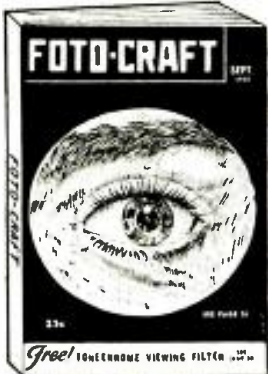

A NEW GERNSBACK PUBLICATION

The Constructive Photo Magazine

ON ALL NEWSSTANDS

FOR serious-minded amateur photographers, here's a photo magazine, FOTO-CRAFT, vastly different from any you've read. It tells you how and why to do things—it's a constructive publication which shows what can be done with the equipment you have, and how to make handy, photographic accessories. FOTO-CRAFT, with its broad editorial features, covers such important branches of photography as—New Scientific Researches; Developing; Printing; Enlarging; Dodging; Cropping; Photomicrography; Color Photography; Amateur Movies; How to Make It Items.

A Few of the Articles in the Current Issue
What Makes Good Photograph—Making Photos Without a Camera—A One-Eye Stereoscope—A Color Transparencio-Scope—Pistol or Gun Grip for Your Camera—Edge and Border Designs—Making a Scene Selector—Permanent Retouching Desk—Building a Focus Magnifier—Motor Driven Film Tank—Stamp Photos—Color in Photography—Film and Print Driver—Ventilated, Dustless Garage Dark-room—Making a Dial-Type Film-Tank Thermometer—Combination Spot and Floodlight—Home-Made Pan and Tilt Tripod—Head—Home-Made Emergency Changlink Bag—Creator of Illusions—Photo Quiz—Use Your Enlarger for Copying—Most Bizarre Photo Contest—Hints and Kinks—Questions and Answers—What's New.

Fotocraft—Now Combined with Photo Review and another Free Gift—Tonechrome Viewing Filter. BIG OPPORTUNITY!! Get a FOTO-CRAFT Press Card today—with it you can get permission to take photos which might be difficult to obtain; PRESS CARDS are sent FREE to subscribers of FOTO-CRAFT. Enter your subscription for Seven Months for \$1.00—and get your PRESS CARD immediately.

FOTO-CRAFT
99-R HUDSON STREET NEW YORK, N. Y.

Please Say That You Saw It in RADIO-CRAFT

2nd PRIZE WINNER

(Continued from page 267)

organ chimes from the church tower and also outdoor services. Cost about \$400 complete with all accessories.

Although one system might easily be made to service all of the above purposes it was found more practical to have the three amplifiers. The 70- to 100-watt amplifier has been placed in a more or less permanent location and needs little attention after it has been once adjusted. The 30-watt booster is in the organ chamber and likewise needs no attention. The portable outfit is made available in various locations wherever needed.

Our church has greatly benefited by the public address systems we have. It was the first church in the community to have amplified chimes and they have been found of great publicity value. Public Address, you might say, has placed our church before the community. Installation described above was made at Redeemer Lutheran Church, Barnes and Boyd Avenues, Bronx, N.Y.C.

WM. F. BRUENING

MAKING MILLIAMMETER MULTIPLIERS

(Continued from page 284)

the length depending on the size. It is possible to figure out the shunt resistance value mathematically but the cut-and-try method is really the only accurate and final means. Cut a piece of the wire about 2 feet long to start with. Shunt it across the meter. If the needle drops back from 10 ma. to around 1 ma. you know you have the shunt about right. You can now gauge from the length of the wire and the error whether you should shorten or lengthen the wire. To increase the reading increase the length of the wire, and vice versa.

After you have the correct length get a small thread-spool. Drill holes and wind the wire around the spool terminating the wire under small machine bolts or wood-screws with lugs. (See Fig. 2.) In mounting the resistor care should be taken that the leads are as short as possible. See Fig. 3. A small amount of wire will change the reading considerably. Heavy wire soldered onto the lugs supplied at the terminals must be used for connections to insure low-resistance connections. A final check should be made after mounting. Note that the resistance of the switches, shown in Fig. 4, must be taken into consideration.

This cut-and-try method of determining the value of the shunt resistor can apply to any meter. For example, if a 10 ma. meter is to be arranged to read 50 ma., max. the reading during adjustment would be 1/5th of the full scale. One-fifth of 10 would be 2 ma., the scale reading to which the needle must drop back, etc.

It is possible to use this procedure on any scale; in extending the scale, however, it is common to use a scale from which you can obtain a direct reading by multiplying the reading by a common factor. In the example used you multiply by 10 to give you the actual reading. In multiplying by 10 you simply add a zero. Thus the reading is almost direct. Fig. 4 shows how the multipliers are applied to the meter.

A Bombay news item reports that \$15 radio sets have been perfected to bring radio within the reach of the millions of India's poor to help solve the problem of mass education and to make life more interesting for them. (Maybe India should buy its sets from America where midget A.C.-D.C. receivers can be had for less than \$5.00, wholesale.—Editor)

YOU ASKED FOR...

Quality
AT A
Price



HERE IT IS!
MODEL 432-A

\$17.85 NET

Readrite
RAINGER

- Has RED•DOT Lifetime Guaranteed Triplett Instrument with Two Highest Quality Sapphire Jewel Bearings . . . Sockets for All Tubes . . . Filament Voltages from 1 to 110—A Safeguard against Obsolescence . . . Separate Line Control Meter . . . Neon Shorts Test . . . Etched Panel of Outstanding New Design . . . Approved RMA Circuit . . . Rich Black Leatherette Covered Portable Case—Professional in Appearance.

For Tubes of Today and Tomorrow—the outstanding tube tester value—Checks Local, Single Ends, Bantam Jr., Gaseous Rectifier, the New High Voltage Series (including 117Z6G) and others recently announced. Also has Ballast tube continuity test. Direct Reading GOOD-BAD Meter Scale. Will not deactivate 1.4 volt or other type tubes.

MODEL 432-A-742

• Model 432-A-742 is a combination Tube Tester (Model 432-A) and Volt-Ohm-Milliammeter (16 ranges). Volt-Ohm-Milliammeter section is a separate panel with range selector switch, ohmmeter zero adjuster and jacks, with ranges as follows: AC-DC Volts 0-10-50-250-500-2500 (DC at 1000 ohms per volt); DC Milliamperes 0-1-10-100; Resistance—5 to 500 with 25 ohms at center scale; 0-100,000 ohms and 1/2 megohms. Complete, less Batteries \$26.85 Net.

WRITE FOR CATALOG

Section 1116, College Drive



\$26.85 NET

READRITE METER WORKS, Bluffton, Ohio

BUILD OR MODERNIZE YOUR OWN RECORDING OUTFIT WITH THIS NEW BASIC SPEAK-O-PHONE RECORDING MECHANISM

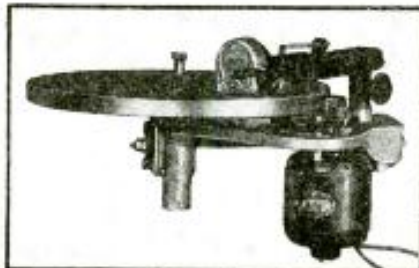

FREE from hum, vibration and bumps, this basic recording mechanism is the ideal central unit for a high quality professional-type recording system. The quality of the recording depends only on the quality of the amplifier and disc used with it.

A heavy-duty, constant speed General Electric motor mounted on a solid vibration-proof aluminum casting is used to rim-drive the turntable. Machined from a one-piece aluminum casting, the turntable is absolutely flat and wobble-free. The recording arm is instantly adjustable for use with acetate, aluminum or pre-grooved discs. Impedance of the cutter is 15 ohms.

The complete unit can be mounted on a mounting board 15 x 15 x 5/16". Full instructions and templates are furnished with each unit. **DEALER NET PRICE \$56.75**

We carry a complete line of recording cutting heads, recording amplifiers, crystal pickups, turntables, etc.

Write or Consult our Mr. Austin on any of your recording problems.

SPEAK-O-PHONE RECORDING & EQUIPMENT CO., 21 WEST 60 STREET, NEW YORK, N. Y.

SPRAGUE ATOMS

"Mightiest Midgets of All"

YOU SAVE 2 WAYS!

Sprague ATOMS (Midget Etched Foil Dry Electrolytic Condensers), save you a whale of a lot of money—and they save space, too! You'll find them far better than most of the big old-style electrolytics for which they are used as universal replacements. Not a "blow-out" in a carload. Unquestionably the highest quality midgets,—the smallest midgets—and the only midgets made in a full line of dual capacity combinations with common negative leads. Write for catalog. See your jobber today!

HOW'S THIS FOR VALUE?

This dual 8-8 mfd. 450 V. ATOM is only 1" x 2 3/4" and lists at only \$1.00. A single 8 mfd. ATOM lists at 60c.





SPRAGUE PRODUCTS CO.
North Adams, Mass.

FREE TRIAL OFFER

NEW REMINGTON NOISELESS PORTABLE! AS LITTLE AS



10¢

A DAY

Famous Remington Noiseless Portable that speaks in a whisper. Pay as little as 10c a day. Guaranteed by the factory. Standard keyboard. Automatic ribbon reverse. Variable line spacer and all the conveniences of the finest portable ever built. PLUS the NOISELESS feature. Act now. Send coupon TODAY for details.

You don't RISK a Penny

We send you Remington Noiseless Portable for 10 days' free trial. If not satisfied, send it back. We pay all shipping charges.

Typing Course and Carrying Case

You will receive FREE a complete simplified home course in Touch Typing, a handsome sturdy carrying case is included. No obligation. Mail coupon for full details—NOW.

Remington Rand, Inc., Dept. 189-11,
465 Washington St., Buffalo, N. Y.

Tell me, without obligation, how to get a Free Trial of a new Remington Noiseless Portable, including Carrying Case and Free Typing Course for as little as 10c a day. Send catalogue.

Name

Address

City State

RADIO COURSES

New Fall Classes Now Starting
RADIO OPERATING—BROADCASTING

- RADIO SERVICING — a practical course
- RADIO AMATEUR CODE ● TELEVISION
- ELECTRONICS—1 yr. day course 2 yrs. eve.

Day and Evening Classes. Booklet Upon Request.

New York Y.M.C.A. Schools
4 W. 64th Street New York City

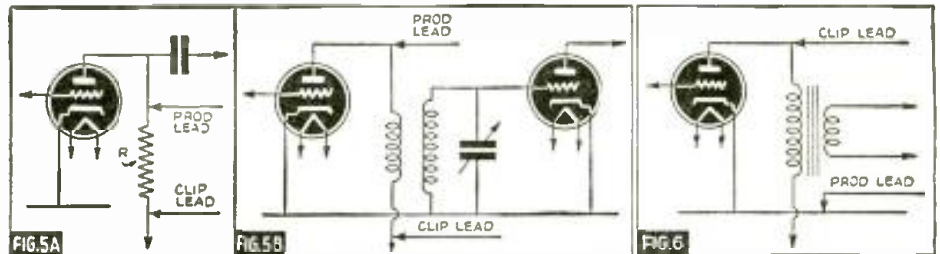

"FADE-OMETER" A NEW INSTRUMENT FOR SERVICEMEN

(Continued from page 280)

sistor, and inductance in parallel so that the current will pass through the condenser and not through the resistor or inductance. See Fig. 3. The high-frequency current follows the path of least resistance which is through the condenser. A resistance or inductance in series with a condenser will have the same effect as the resistor or inductance alone.

The R.F. Power Factor is the internal resistance of a condenser other than the normal reactance of the capacity. In paper condensers it is usually the result of excessive contact resistance at R. (Fig. 1) Connect a 50-ohm resistor in series with a 0.1-mf. condenser and check the entire unit with a Fade-Ometer. The "eye" does not close, thus indicating the presence of a defective unit.

The R.F. Power Factor or internal resistance of electrolytic condensers makes them unfit for R.F. circuits unless shunted by a small paper condenser to correct the power factor (see Fig. 2). This internal resistance, however, is of no consequence when the condenser is used for filtering purposes at 60 cycles only. Test several new wet electrolytics with the Fade-Ometer. If any test bad shunt them with a small paper condenser and test again. Electrolytic filters used in R.F. circuits should *always* be shunted by small paper bypass condensers.

The new test unit provides a practical method of testing radio parts, especially condensers, with the radio receiver in actual operation. (*) It is *not necessary* to disconnect any condenser in a radio circuit to test it for open, intermittent, or R.F. power factor.

It is *not necessary* to disconnect condensers C (Fig. 3) from R or I to test for open, intermittent capacity, or R.F. power factor. To illustrate: connect CAPACITY test leads across a 50-ohm resistor or any R.F. coil. The "eye" will not close. Bypass the resistor or coil with a condenser and test again. The "eye" will close.

Testing C for shorts or intermittent leaks would necessarily require disconnecting as a D.C. continuity test must be used. A leaking or shorted condenser would cause incorrect bias on the tube, effects of which would be obvious. A locking feature is also provided that automatically *locks* the indication of a defective part, making it unnecessary for the technician to maintain a constant watch over the test.

There are 4 jacks across the bottom of the panel marked A.C.—OUTPUT—D.C., CONTINUITY and CAPACITY. All condenser tests are made from the CAPACITY jack, and direct current continuity tests from the CONTINUITY jack. The output jacks are for the purpose of using the "eye" as an infinite-ohms-resistance vacuum-tube voltmeter which draws no current from the circuit tested.

The test leads consist of a phone plug and 2 leads attached. One lead is equipped with a black alligator clip and the other with a

handy banana prod. Two additional alligator clips are provided for attachment to the prod. One is black and the other is red. The red clip contains a resistor in the handle and is for use around A.V.C. systems, R.F. grids, plates, etc., and prevents bleeding or detuning of the circuit.

A ground lead with pin and clip is to be used only in cases when operation of the test unit causes hum or distortion. This is usual when testing audio coupling condensers and can be eliminated by connecting the Fade-Ometer ground to the set chassis. In no case should the radio set or test instrument be connected to an external ground. No harm would result but the test operation may be upset.

DEFECTIVE CONDENSER

Defective condensers are probably the greatest source of radio complaints. A condenser that is completely shorted is usually no problem for the average Serviceman, but the open or "intermittent" condenser will sometimes cause the most experienced technician considerable trouble to locate. There are usually a number of bypass and coupling condensers in a radio that can cause trouble with similar symptoms. Disconnecting to test intermittent or critical condensers is impracticable as the condenser is never open when tested. If by chance it should be open ordinary testers will invariably *heal* the condenser temporarily upon application of the test prods. The method of substituting good condensers is just as laborious and unreliable. At the best it is a guessing method and should be eliminated.

If fading or oscillation is the complaint the technician should be able to assume with some assurance approximately where the trouble is. If the set volume drops very low or cuts out completely one can be reasonably sure that a coupling condenser is defective. If the volume drops only slightly or oscillation occurs, an R.F. bypass, A.V.C. filter, or audio bypass should be suspected. A complete loss of signal with an increase in hiss, tube noise, or static, usually indicates that the oscillator has stopped oscillating, which may be due to a defective condenser or resistor in that circuit. Intermittent or continuous R.F. oscillation is usually due to defective bypassing. The stage that is oscillating can easily be determined by touching the grid caps of the various stages with the finger. The stage that most effectively stops the oscillation is the one that is oscillating.

To check condensers plug the leads into the CAPACITY jack. Use the prod with or without the black clip as desired but *do not* use the red clip. Touch the leads to the condenser terminals. If the "eye" closes the condenser is good, if it opens the condenser is defective. If the condenser is suspected of being intermittent try tapping the condenser lightly, tugging at the leads, etc., while under test. A test resulting in an open indication means that the condenser is too low in capacity, is open, or has too high R.F. power factor. See Fig. 1.

*See "Point-to-Point Capacity Testing," Radio-Craft, July, 1933.

Please Say That You Saw It in RADIO-CRAFT

Electrolytic filter condensers are not ordinarily tested with the Fade-Ometer except to measure R.F. power factor. If one should test defective it should not be discarded if it tests good otherwise, as it is still perfectly good for filtering for which it was intended. However if such a condenser is used in an R.F. circuit it should be shunted with a small paper or mica bypass condenser of about 0.05-mf. capacity, as explained above.

To check intermittent condensers by means of the INDICATOR LOCK, tune the radio receiver to a broadcast signal. Do not use a local signal generator or service oscillator. Plug the leads into the CAPACITY jack. Use black clip on the prod and attach the clips to the suspected condenser. In the case of audio coupling condensers this may cause hum or distortion and can be corrected by using the ground connection from the test unit to the set chassis. Do not use an external ground. Disconnect one clip at a time to check the set-up for proper operation. Set the locking switch to "locking" and repeat test for proper operation. Reset the locking switch by returning to "Manual" and then to "Locking." Note: The black clip should always be connected to the point that is nearest chassis electrically (see Fig. 4). If set-up is now correct let the radio set play continuously until a fade period occurs. If the trouble is due to the part under test, the "eye" will open and stay open, even should the part return to normal. If the trouble is not located in this test repeat on other suspected parts until the defective one is located.

DEFECTIVE CONDENSERS

To check coils, resistors, chokes, transformers, etc., for open circuit, plug the leads into the CONTINUITY jack and proceed with any ordinary continuity test. Do not attempt to test any part that has a voltage drop across it as that shown in Fig. 5A. To test, turn the radio receiver off. Coils such as used in R.F. grid or plate circuits may be conducting current with the radio set on but test can be made with the receiver in operation. Resistors usually have a considerable voltage drop across them and should not be tested with the set on. Do not use the ground connection to radio chassis when making these tests. The locking feature will operate with the continuity tests where the tested resistance is low and the red clip is not used. To check R.F. coils while the radio set is operating use the red clip on the prod to prevent bleeding or detuning the circuit. Direct-current continuity tests can be made across the primaries of R.F. coils (see Fig. 5B), with the radio set operating, as, due to its low D.C. resistance, there is no appreciable voltage drop across the coil. Do not ground Fade-Ometer to set.

To use the output indicator for set alignments, plug the leads into the "A.C." output jack when taking an audio signal from the set output. See Fig. 6. (Here exception is taken to the rule established in connection

with Fig. 4 in that the prod lead goes to radio chassis and the clip lead to plate.) Adjust the radio set volume control until the "eye" is nearly closed. Proceed with alignment as usual, reducing the volume control as alignment proceeds. To take indication from the A.V.C. system (recommended whenever available) plug leads into "D.C." jack and use the red clip on the prod. When using A.V.C. voltage for measurement or alignment purposes connection can be made to any point in the A.V.C. network as shown by arrows 1-2-3-4 (Fig. 7). Connection must be made with the clip lead to chassis or diode cathode and the prod lead using the red clip to the negative voltage supplied by the diode. If audio signal is also supplied by the diode as shown, A.V.C. voltage cannot be taken from arrow points 1 and 4.

Arrow point 3 is recommended as the best point to connect the prod lead in most cases.

To set up automatic tuning on pushbutton-tuned radio sets, attach the black clip of the new test unit to the set chassis and its red clip to any A.V.C.-controlled grid cap. Adjust button settings for maximum closing of the "eye". If "eye" over-closes use a shorter aerial to reduce the signal.

To use a vacuum-tube voltmeter, plug leads into jacks "D.C." and use red clip on the prod. The device is then operating as an infinite-ohms-resistance vacuum-tube voltmeter and draws no current from the circuit tested. The prod lead is negative. See Fig. 7. As it takes 8 volts to close the eye of a 6E5 tube or 22 volts to close a 6G5, a fairly accurate estimate of voltage measurements can be made. A greater voltage than specified for the particular tube will over-close the eye and a lesser voltage will open the eye in varying degrees. The use of the vacuum-tube voltmeter is valuable in checking A.V.C. voltages and they can be measured quite accurately with little practice. An ordinary service voltmeter even if of extremely high internal resistance is of no value whatsoever for the above uses.

This article has been prepared from data supplied by courtesy of "Fade-Ometer" Company.

HINTS ON PORTABLE SOUND

(Continued from page 283)

for portable work, but most cone speakers do not project enough high-frequency sound. Furthermore, those that do project high frequencies, do so in a rather narrow angle about the axis of the voice coil. The efficiency of a good exponential horn and unit is much better over the frequency range covered, than that of a good cone speaker with a baffle horn. In most cases, the cost of the exponential speakers is substantially higher than the cost of cone speakers, but if they are within financial reach, will easily pay for themselves in better and crisper speech. The greater efficiency of the horn speakers also permits the use of a smaller output amplifier, and consequently, permits using a lower-cost power supply.

The best part of the Public Address year lies ahead. Those who do their remodeling now are the ones who will profit most. BUT don't stop your renewal when you have brought your equipment up-to-date; bring your psychology up-to-date, too. The following points are always psychological dynamite:

- (1) Be brief. Mean what you say, and say it DISTINCTLY.
- (2) Present a good appearance. (This may be an old saw-horse, but she still wins the races.)
- (3) Be persistent. Go after that business every day, and don't let down when it does start coming to you.

This article has been prepared from data supplied by courtesy of Huber Sound Systems.

Beginners—

How to build a simple 1-tube pocket radio set for local reception will be described in the December issue of Radio-Craft. Don't miss it!

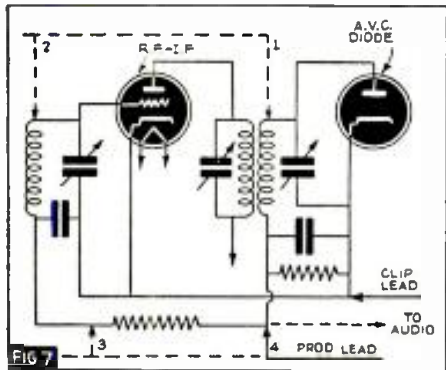

MY FREE BOOK SHOWS HOW YOU CAN BECOME A MONEY-MAKING RADIO EXPERT!

with my New
SPRAYBERRY
Personalized
HOME TRAINING
in
RADIO AND TELEVISION

EASY TO START... EARN WHILE YOU LEARN

I Train You Quickly in Your Spare Hours . . . Right at Home

You Do Practical Experiments with Real Equipment

I offer you a new and altogether different type of practical training for a money-making career in Radio and Television. I teach you in a simplified, logical, understandable style . . . all about Television, Electronics, Facsimile Radio, Radio Set Repair and Installation. I GIVE YOU PERSONAL COACHING ALL THE WAY.

TRAINING PREPARES YOU FOR GOOD RADIO JOBS . . . at Excellent Pay

No matter if you desire to BE YOUR OWN BOSS in your own business or hold down a good job in Radio, my Training will give you the useful information and knowledge to win success. DON'T JUST WISH FOR MORE MONEY—START TRAINING FOR IT RIGHT NOW.

Read What This Student Says:

EARNED \$250 SINCE STARTING COURSE
"I have only completed one-third of the Sprayberry Course and I find it very interesting, which makes it easy to learn."
"By devoting several hours of my spare time daily to studying and servicing, I have made about \$250 gross since starting the course." Earl W. Hostetter, R. No. 4, Lebanon, Pa.

YOU GET PROFESSIONAL TEST EQUIPMENT PLUS EXPERIMENTAL OUTFITS

Includes 146 RADIO PARTS for building a complete 5-tube Radio Receiver, RADIO TOOLS, ALL-WAVE, ALL-PURPOSE ANALYZER. Besides its invaluable use in experimental work, my Equipment will enable you to make spare time profits while you're learning and can serve you in your own service business later on. I give you DATA SHEETS on how to build popular Radio circuits. Also you receive BUSINESS BUILDERS which show you how to get and do spare time, neighborhood Radio Service work.

NO PREVIOUS EXPERIENCE NEEDED

My Training starts right at the beginning of Radio and covers all essential subjects. It makes no difference what your education has been. I can fit you for an excellent paying job in Radio. Your success is my full responsibility. I know how to get Radio across so that you will understand it . . . and remember it.

SERVICEMEN

I offer Advanced Training for those already in Radio. Get complete details in my FREE 52-Page Book.

REMEMBER—THE SPRAYBERRY COURSE IS SOLD UNDER A MONEY-BACK AGREEMENT

RUSH THIS COUPON FREE for BIG FREE BOOK

DON'T DELAY! ACT NOW!

SPRAYBERRY ACADEMY OF RADIO
F. L. Sprayberry, Pres.
220-L University Place, N.W., Washington, D. C.

Please send me FREE copy of "HOW TO MAKE MONEY IN RADIO."

Name Are
Address
City State
Tear off this coupon, mail in envelope or paste on penny postcard. Servicemen—Check here

Please Say That You Saw It in RADIO-CRAFT

DIRECT-COUPLED AMPLIFIERS

Designed by A. C. Shaney



These new 10, 20 and 30 Watt Direct-Coupled (Push-Pull Loftin-White) Amplifiers are now available with any one or more of 14 optional features, including Variable Speed Non-Overloading Push-Pull Expander, High Frequency Accentuation and Attenuation, Low Frequency Boost and Cut Control, Push-Pull Automatic Volume Compressor, Push-Pull Automatic Volume Limiter, Push-Pull Automatic Volume Control, Non-Frequency Discriminating Scratch Suppressor, Low-Gain Single Ended Input, High-Gain Single Ended Input, Low-Gain Push-Pull Input, High-Gain Push-Pull Input, Audio Spectrum Control, Calibrated Volume Indicator, and Push-Pull Remote Control.

Write or Wire Today for Complete Details and Unusually Attractive Prices.

AMPLIFIER CO. of AMERICA

17 WEST 20th STREET NEW YORK, N. Y.

● EASY—SIMPLIFIED—PRACTICAL ●

ELEMENTARY MATHEMATICS

A book for the Technician and Craftsman, explaining and answering every meaning with illustrations. A real study-course in mathematics for the student or the man who wants to brush-up on his knowledge.

CONTENTS OF BOOK

I. ARITHMETIC: Addition, Multiplication, Division, II. Factoring and Cancellation, Fractions, Decimals, Percentages, Ratio, and Proportions. III. The Metric System. IV. How to Measure Surfaces and Capacity (Geometry). V. POWERS: Involution—ROOTS: Evolution. VI. Mathematics for the Manual and Technical Craftsman. Thermometer Conversions, Graphs or Curve-Plotting, Logarithms, Use of the Slide-Rule. VII. Special Mathematics for the Radio Technician. VIII. Commercial Calculations. Short-cut Arithmetic, Interest, Discounts. IX. Weights and Measures. Useful Tables.

ONLY **50c** POSTPAID

Stamps, Cash or Money Order

TECHNIFAX

Division RC-1139

1915 S. State St.

Chicago, Ill.

NEW! TURNER

CRYSTAL MICROPHONE HAS REMOVABLE CABLE SET AND TILTING HEAD AT LOW PRICE

Turner 22X is the only mike at this low price with full 90 degree tilting head and interchangeable cable set. Amazingly free from feedback. Protected for hams, rugged enough for the toughest P.A. jobs. Full satin chrome plating. Professional appearance. Features and performance equal to many \$25 mikes.

\$16.50 list

Write for Free Information

The TURNER CO.

907 Seventeenth St., NE CEDAR RAPIDS, IOWA

Licensed Under Patents of The Brush Development Co.



MODEL 22X 30-7000 cycles High level 52dB Complete with 7 ft. cable set.

GET THIS FREE BOOK!

Only a few copies of the RADIO REFERENCE ANNUAL are still available! It's the BIG, FREE BOOK of 64 pages you receive when you subscribe to RADIO-CRAFT. The ANNUAL covers set building, servicing, public address, test equipment, plus a number of other interesting topics. Send your remittance of One Dollar to RADIO-CRAFT, 99-R HUDSON STREET, New York, N. Y., and you will receive a subscription to RADIO-CRAFT for Seven Months, and your copy of the RADIO REFERENCE ANNUAL will be mailed postpaid immediately.

RADIOS SAVE UP TO 50%

DEAL DIRECT-FACTORY PRICES! Many models to choose from at wholesale prices. AC-DC midsets \$4.98. Portable and battery sets \$8.98 up. Car sets \$11.75 up. Also consoles, all-wave etc. Samples at 50% off. Send for FREE 1041 bargain catalog giving details of 10 day FREE trial and agent's proposition and discounts. No obligation, write today.

4.95

Free Catalog

R.C.A.

GOLDENTONE RADIO CO., DEPT. RC, DEARBORN, MICH.

AN EASILY-BUILT STAGE ANALYSIS TESTER

(Continued from page 279)

Headphones may be plugged directly into the output jack of the R.F.—I.F. channel. Again, the input circuits of this channel are so designed as to not affect the circuit of the receiver in any way or upset the operating conditions and voltages. Determination of signal leakage may be made while location of distortion and undesired oscillation ahead of the detector is also readily accomplished. Gain measurements in coils and tubes may be made accurately and rapidly; and antenna efficiencies are easily compared. Open bypass condensers can be located without disconnecting a wire.

Line Current Channel. The *Line Current* channel as its name implies, provides an indication of the amount of current being drawn from the power line by the receiver under test. Changes in this current, or abnormal values thereof, will sometimes provide the only indication of the trouble, especially when testing intermittent receivers.

INTERMITTENT OPERATION

The Analyst is particularly adapted to solving the troubles that exist in receivers that are intermittently operative, that is, receivers that "cut out" for an apparent reason. If servicing is attempted by the ordinary methods, the mere connection of test instruments frequently restores the set to its normal operating condition and many hours of effort are sometimes necessary before it is possible to locate the faulty unit.

By means of the Analyst, which has 5 indicators to check the performance of the receiver at as many strategic points simultaneously, it is possible to localize the fault to a certain portion of the receiver the *first time* that the signal fades.

Figure 2 shows a block diagram of a conventional superheterodyne receiver and the points where the various channels of the Analyst are normally connected for the first test on an intermittent receiver. Figure 3 shows, in a similar type of diagram, the most logical places to connect the indicators to a conventional T.R.F. receiver.

The controls can be set so that all 5 indicator shadows just close. Then, if a fault occurs, the appearance of some, or all, of the indicators will change, indicating the portion of the receiver in which operation is not normal. In other words, all of the necessary test instruments are connected to the receiver before the fault occurs so that they may be observed during the faulty operation of the receiver without disturbing the set. Formerly the disturbance occasioned by connecting test instruments frequently restored normal operation, and stopped any chance of finding the defective part until the next fade, at which time again the process of testing may have restored

normal operation making it virtually impossible to find the defective part except by sheer good luck or by the expenditure of a prohibitive amount of time.

If the last indicator that shows *normal* signal, and the first indicator that shows *abnormal* signal, are separated by several circuits or stages, it is usually possible to attach the test prods to points closer together for the second test to restrict the part of the receiver under test so that on the second fade the defective part can be located more closely. Sometimes a third operation is possible, narrowing still more the region that must be closely inspected for the faulty unit, but usually the region is so restricted by the second test that it is a simple matter to locate the defective part.

The points to which the indicators are connected for the second test will occur naturally to the Serviceman after observing which indicators showed abnormal signal in the first test.

(Ordinarily, the practical Serviceman finds little difficulty utilizing components he may have on hand in the construction of equipment broadly classed as "kits." In the instances of the Analyst, due to the required exactness in the mechanical and electrical values of the components, it is recommended that the specified parts be employed; for this reason, too, the kit's components are not available separately.—Editor)

This article has been prepared from data supplied by courtesy of Meissner Mfg. Co.

HOW TO BUILD A "JUNKBOX" ELECTRIC GUITAR

(Continued from page 271)

a phase inverter, would have been sufficient without this extra stage, but I didn't have a 53.

So the lineup as given in the diagram was used. The gain is such that the speaker can be overloaded when talking with normal voice level into a crystal mike plugged into the input. A vicious hum, probably originating in the input transformer, was killed by the 100,000-ohm resistor from grid to grid on the 45's. The amplifier weighs about 50 pounds, and a good portion of this is Mr. Majestic's massive speaker and transformers. If lighter parts are available the weight could be cut down to where the instrument would be portable without the aid of a derrick.

The basis of the pickup were 2 Peerless magnetic speakers, which would no longer speak, but the motors were still OK. Three of the 4 coils, and 1 of the magnets, were used. The coils have a rather small hole through them, and so 3/16-inch screws were the largest I could use. If these coils are not at hand, coils for RCA speakers, which are about the same size are available from supply houses. The 2 plates were made from flat iron, about 3/8-inch wide and 1/2-inch thick.

One was cut long enough to accommodate the 3 coils, spaced so each one would be located in the center of a pair of strings, then drilled and tapped for 3/16-inch stove-bolts. Fillister-head machine screws would be better for the screws through the coils, but I had no tap for these so stove-bolts were used. The center bolt is long enough to go through the magnet, and a 3/8-inch spacer (iron or steel) holds the coil assembly away from the magnet, leaving room for the guitar top between the coil plate and the magnet.

The other plate is cut enough longer so that it can be screwed to the guitar top, and two of the spacers are used on this, as this plate should come about even with the

Please Say That You Saw It in RADIO-CRAFT

tops of the screws on the other one.

A 1/2-inch hole is drilled between the 2 center strings for the spacers on the plate to pass through, and is fastened to the top with the stove-bolts, using enough washers under the plate to bring it close to the strings. Mount it as close to the bridge as possible. And, when you drill the hole in the top, proceed very carefully; I didn't and had a hole in the back, too.

The front plate is spotted, and a hole cut out with a pocket knife to just pass this plate; the leads from the coils which are all connected in series, are brought out to a terminal block, and the whole thing is screwed in place. The accidental hole in the back was very handy for tightening the center screw. But, if you don't have the hole, an offset screwdriver will do the trick. The whole works can be inserted through the sound hole, and no holes are necessary in the back.

Use a shielded cable, to run from the guitar to the amplifier, or the stray pick-up will be terrible. I used ordinary auto lead-in wire and an auto-radio antenna connector for the shielded plug. Ground the sheath on the cable to the chassis of the amplifier, and connect all the metal parts of the pick-up to the sheath, and the stray pick-up will be very low.

A volume control may be built into the guitar, if desired, about 1 megohm should do; and, a tone control can be added if desired—connect it grid-to-grid, or plate-to-plate of the 45's, depending on the size of control available.

So ends the story of the metamorphosis of the junkbox, and I hope any of you boys who build this will have as much fun, and as little expense as I.

USEFUL KINKS AND CIRCUITS

(Continued from page 284)

to "Ant." and "Gnd.," respectively, on the set.

If the rule is tilted slightly backward, it will remain rigid in anything but a strong wind.

J. SMAILE,
Adelaide, S.A.

(Reprinted from *The Australasian Radio World*.)

PLUG-IN MIKE

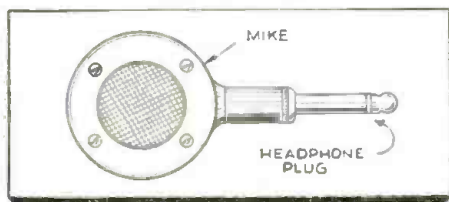

● PRACTICALLY all microphones of the crystal, dynamic and velocity types have a 3/8-27 female thread. Likewise most mike and phone plugs have a 3/8-27 male thread. A plug can be screwed into the microphone to make a very nice connector. The jack can be mounted in a small metal box with an off-on switch. This is very good practice for public address work since the mike itself can be readily unplugged when the operator leaves and plugged-in again just before it is to be reused. This eliminates damage due to tampering. It also is practical because different types of mikes can be interchanged without threading the cable through the stand every time. It also provides an efficient swivel joint.

Be sure to connect the shield wire onto the shaft terminal.

ROBERT DEHAAN, W8SKY,
Grand Rapids, Mich.

(Continued on page 310)

Because
RCP
can't be beat for
PRECISION
and **PRICE**

it's the
world series winner
in test equipment

Here are five all-stars in RCP's complete test equipment line-up. Check the features, check RCP accuracy and reliability with the performance you are getting now and—most important—check RCP's moderate prices. Discover for yourself why RCP is the field's top-value today . . . why this test equipment series has become the world series winner. Send for complete profit story.

RCP Signal Generator Model 702

EVEN FINER PERFORMANCE than RCP's former signal generator, and that was an outstanding buy!

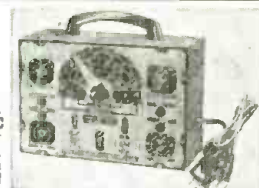

Has all latest improvements in circuit and mechanical design. Extremely wide all wave coverage continuously variable from 95 Kilocycles to 100 Megacycles. Output modulated at will. 30% modulation at 400 cycles, sine wave from self-contained independent 400 cycle circuit. Can be used with outside sweep circuit and wobulator for all forms of Oscilloscopic wave analysis. Attenuation in approximate micro-volt calibration by means of five step ladder attenuator. Triple shielded. Highly attractive professional appearance. AC operated. **\$22.95** Net.

RCP Pocket Multitester Model 413

IT TOOK RCP to design a pocket size instrument with all the sensitivity, ranges and features of the large expensive testers. Here is the same quality and accuracy of component parts, but think of the size and the money you save! Sensitivity: 400 microamps, or 2500 ohms per volt. Fine Alnico magnet identical to that used in ultra-sensitive, high cost meters. AC volts: 0/10/50/250/1000/5000. Ohms: 0/500/100,000/1,000,000. DC Microamps: 0/400; DC Milliamps: 0/10/100/1000; DC Amps: 0/10. In attractive natural finish wood case. Net **\$12.90**



Pocket size Multitester Model 412—Identical except less the 5 AC voltage ranges. **\$9.95**

RCP Combination Tube and Set Tester Model 801

NOWHERE COULD YOU BUY these two essential instruments individually and get them a much higher quality at the same low price. Tests all new and old tubes and ballast tubes; hot interelement short and leakage tests on each individual element. Smooth line voltage regulator from 115 volts with direct meter indication. As Multi-tester, Model 801 provides four range D.C. voltmeter 0/10/50/500/1000; A.C. volt meter 0/10/50/500/1000; D.C. milliammeter 0/1/10/100/1000; D.C. ammeter 0/10; 4 range ohmmeter up to 10 meg-ohms. Also, D.B. meter and output meter. Fused 4 Arsonval Meter, Alnico Magnet, Compact, light, with slip hinge cover case. Complete with tube, battery and test leads. Net. . . . **\$27.95**

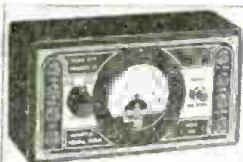
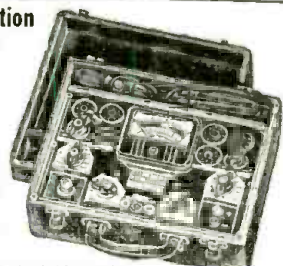

RCP Universal Trouble Tracer Model 456

TOPS IN A FINE POCKET SIZE AC-DC volt, ohm-, d.b., and milliammeter. Special ohmmeter shorting switch—no fussing with leads or jumpers. Movement: 1 Milliampere or 1000 ohms per volt. DC volts 0/5/50/500/1000; AC volts 0/5/50/500/1000; DC Milliamp 0/1/10; Ohms 0/5000/500,000. D.B. -12 to 8/8-28-28-48/34-54. Attractive **\$7.95** hardwood case. Net

RCP Dynoptimum Test Tube Checker Model 308

Tests (under R.M.A. specified plate voltages and loads) 35-45-50-70 up to 117 volt tubes all metal, M.G. glass, OZ4, cold cathode rectifiers, octal, loctal and single end tubes. Tests all ballast tubes (separate chart included). Hot interelement short and leakage test between ALL INDIVIDUAL ELEMENTS. Provision for audible test of noisy tubes. **\$16.95** Net



See your jobber today, or write direct for detailed information on the complete RCP line.

RADIO CITY Products Co.
88 PARK PLACE NEW YORK CITY

SOLAR
WAX-MOLDED
Sealdtite
Tubular Paper Capacitors molded in hard wax . . . no moisture can enter . . . much longer life . . . buy from your jobber in factory-sealed cartons.
Write for Catalog
SOLAR MFG. CORP. Bayonne, N. J.

RADIO plus TELEVISION

mastered by pre-tested Training

No matter where you are or what you do, National has a complete training plan for you—to fit your circumstances. National plan is for those seeking immediate job-training as well as for those who cannot give up present employment and income. Mail coupon.



NATIONAL SCHOOLS

NATIONAL SCHOOLS, Dept. 11-RC
6000 So. Figueroa St., Los Angeles, Calif.

Please send free literature and full details

NAME _____ AGE _____
ADDRESS _____
CITY _____ STATE _____

Please Say That You Saw It in RADIO-CRAFT

USEFUL KINKS AND CIRCUITS

(Continued from page 309)

OLD TUBE PROTECTS SET

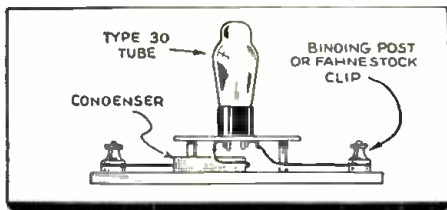

● RADIO owners who use one side of the power line as an antenna through a condenser could make use of this simple kink as a means of protecting their receivers from damage in case the antenna condenser breaks accidentally or short-circuits. In the illustration is shown how this is done.

A worn out or poor tube, usually available in the junk-box, but having its filaments still in good condition is used as a fuse. Two brass tubings or spacers are used to support a wafer socket, for the tube to be used, on a wooden base. The antenna condenser is connected in series with the filament of the tube, as shown.

This gadget could be placed on the receiver's chassis, if convenient, and would make the set a "one-more-tuber". Or it could be screwed to the inside of the cabinet.

MANUEL MADRIDANO,
Sta. Cruz, Manila, P. I.

CODE PRACTICE OSCILLATOR

● THE circuit shown is without any doubt, in the opinion of the writer, the simplest, yet most useful one ever published. It uses the new 1A5G tube which operates on 1.4 volts on a simple flashlight cell, and which

requires only 70 milliwatts of filament power. For this reason it is inexpensive to operate. And since the batteries are small, the whole unit can be built to fit into a small space (or bread-board style, if preferred).

Since the oscillator emits a pure R.F. signal, it has to be rectified like any R.F. signal in order to be heard on phones or loudspeakers. The circuit constants given are for the broadcast band, however several harmonics are present, and the harmonics can be heard on the S.-W. band. The builder will not be violating any laws since the power is extremely small. If only 6 volts are applied to the plate the output should be connected directly to the antenna and ground post of the radio receiver. However some receivers are so sensitive the unit can be placed in another room and the signal will be quite strong.

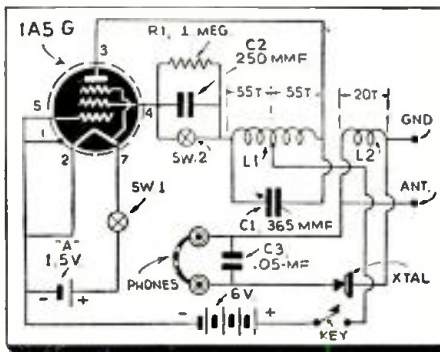

The circuit is self-explanatory and needs no detail. Switch Sw. 2 is the modulation

switch. With the switch open a high-pitch signal will be heard in the phones. When the switch is closed the R.F. signal is still present only it is unmodulated; this can be verified by a receiver with a tuning eye, the eye will almost close whether modulated or unmodulated.

The coil, 1¼ ins. in dia. and wound with No. 32 ga. enamel wire, is center-tapped, leaving a ½-in. space at the center.

The key can be placed in either the positive or negative lead as long as the operator's body does not come in contact with any bare part. A long, insulated shaft connected to the condenser rotor will eliminate body-capacity in tuning.

A crystal detector may be used in a nearby room to receive the signals; no matter where transmitter tuning condenser C1 is set, the signal will still be heard in the phones. Receivers, however, must be tuned exactly to the oscillator frequency in order to pick up the signal.

The parts required, and which can be found in the average junk-box, are as follows: 1—1A5G tube; 1—octal socket; 2—S.P.S.T. switches, Sw.1 and Sw.2; 5—1.5V. flashlight cells; 1—key; 1—crystal detector, XTAL; 1 pair headphones; 1—1-meg. resistor, R1; 1—250 mmf. condenser, C2; 1—0.05-mf. condenser, C3; 1—365 mmf. variable condenser, C1; 1—coil form, 1¼ ins. dia., and 2 or 3 ins. long, wound with No. 32 ga. enamel wire; 4—fahnestock clips; connecting wire.

P.S. With switch Sw.2 closed the unit once it is calibrated becomes a heterodyne frequency meter.

E. B. DEWELL,
Petersburgh, Va.

RSA is the only organization of Servicemen that has the sponsorship of the Radio Manufacturers' Association and the Sales Managers' Clubs, as well as the endorsement of the entire industry.

RSA is proud to announce that final details of plans for complete cooperation with the NAB, through local broadcasting stations, are rapidly being completed.

RSA chapters will soon receive, free of charge, complete Television Course for instruction in television servicing and installation.

RSA has helped thousands of its members solve technical problems during the past year. Membership quotas in some sections of the country have been practically completed. Servicemen! Contact the RSA immediately for details of membership!

RADIO SERVICEMEN OF AMERICA, Inc.

JOE MARTY, JR., EXECUTIVE SECRETARY
304 S. DEARBORN STREET, CHICAGO, U.S.A.

“ Mr. Serviceman:
You're in Good Company
When You're in the R.S.A! ”

Let's Grow Together in 1939!



MAIL THIS COUPON NOW!

RADIO SERVICEMEN OF AMERICA, INC.
304 S. Dearborn St., Chicago, Ill.

Name

Address

City State

I am interested in RSA Membership. Tell me about it.....

I am enclosing \$4.00 for National dues and initiation.....

(Does not include Local Chapter dues where Local Chapters are organized.)

RC-1139

Please Say That You Saw It in RADIO-CRAFT

RADIO AND INTERPHONE

(Continued from page 288)

is comparable to any good 4-tube A.C.-D.C. receiver. If any hum is noticeable above that which would be expected of such a set the filter choke is most likely to blame. It has been my experience that A.C.-D.C. radio sets require a well-designed choke when using a P.M. speaker, for in the absence of the hum bucking characteristic of a field coil type speaker, the choke must have low resistance to keep the voltage up and still have adequate filtering properties. About 400 ohms or less is satisfactory for the choke.

The power and sensitivity of the sets I've built were more than satisfactory.

The chassis was made of lead-coated steel. Its construction should present no difficulties to anyone with a hand-drill, tin snips and a piece of square steel (for a bending form).

The circuit diagram, Fig. 1, is self-explanatory. Parts values are given in the diagram. The 5-inch type P.M. speaker was found to give better tone than the 3- or 4-inch type. One precaution which should be observed on this or any other A.C.-D.C. type equipment, is to select control knobs of the push-on type, or with set screws deeply recessed. This rule should most especially be observed when the instrument is used in the proximity of grounded objects such as stove, sink, etc.

(The article "A Home Wired for Radio", mentioned by Mr. DeVoe, appeared in the Jan., Feb., April, June and July, 1939, issues of *Radio-Craft*. Incidentally, it is believed that the first published description of a combined radio and interphone was the 2-part story "How to make the *Radio-Craft* De Luxe Carrier Interphone," in the May and June, 1937, issues.—*Editor*)

LIST OF PARTS

SPRAGUE CONDENSERS

- One 0.001-mf., 600 V., C1;
- Two 2-gang, 350 mmf., C2, C3;
- Five 0.1-mf., 400 V., C4, C6, C7, C10, C15;

- One 16 mf., 200 V., C13;
- One 8 mf., 200 V., C14;
- One 10 mf., 35 V., C11;
- One 0.02-mf., 600 V., C9;
- One 100 mmf., 400 V., C8;
- One 0.006-mf., 400 V., C12;
- One 10 mf., 35 V., C5.

IRC RESISTORS

- One 20,000 ohms or up to 50,000 ohms, antenna shunt, C-bias volume control, R1;
- One 300 ohms, ½-W., R2;
- One 5,000 ohms, ½-W., R3;
- One 0.25-meg., ½-W., R4;
- One audio grid taper volume control, 50,000 ohms, R5;
- One 2 megohms, ½-W., R6;
- Two 0.5-meg., ½-W., R7, R8;
- One 150 ohms, 1 W., R9;
- One 5,000 ohms, ½-W., R10;
- One 40 ohms, 10 W., R11;
- One line cord and resistor, 180 ohms, R12.

MISCELLANEOUS

- Two Centralab 2-pole, 2-position switches, Sw.1, Sw.2;
- Two (or more) speakers, 3- or 5-in. P.M. dynamic;
- Two "single pentode to voice coil" transformers (these come with the speakers), T1, T2;
- Two antenna and R.F. coils to match C2 and C3, L1, L2;
- One 40-ma. filter choke (not over 200 ohms), L3;
- One home-made chassis, 5 x 9¼ x 1¼ ins. deep;
- One dialite, 6-8-V., 150 ma.;
- One 2-terminal strip (to connect remote speaker);
- Tie points, lugs, screws, push-back wire;
- Cabinet and knobs to suit the builder;
- One type 25L6 tube;
- One type 25Z6 tube;
- One type 6K7 tube;
- One type 6J7 tube;
- Four octal wafer sockets.

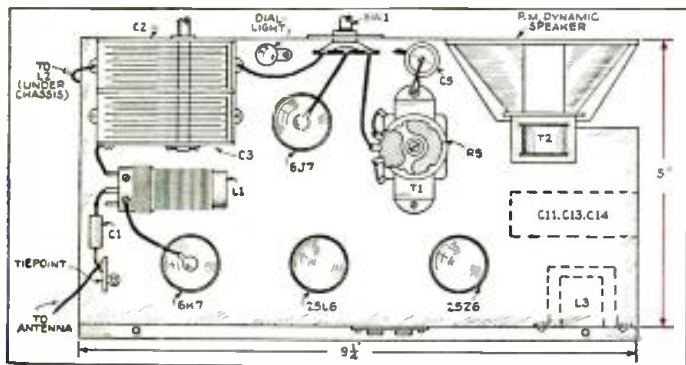

Sketch of chassis showing the location of all main components.

REVIEW OF F.C.C. ALLOCATIONS OF ULTRA-SHORTWAVES

(Continued from page 274)

fall within the bands 30,000-40,000 and 132,000-140,000 kc.

COASTAL AND SHIP HARBOR

The allocations to coastal and ship harbor stations have not been changed except to reduce the allocation by one channel which was necessary to fill the needs of broadcasting and aviation. These stations are used for the purpose of providing a short-range harbor service similar to that now authorized in the frequency bands 2,100-2,200 kc. and 2,500-2,600 kc.

SPECIAL EMERGENCY

Except for the deletion of one of the original frequencies contemplated in Order 19, the revised order maintains the existing

allocation to special emergency stations. Special emergency stations are covered by the rules and regulations governing the emergency service. A license for this class of station is issued only to an organization established for relief purposes in emergencies and which has a disaster communication plan, or to persons having establishments in remote locations which cannot be reached by other means of communication, or to public utilities.

MARINE FIRE

The previous allocation to this service remains unchanged and is for the purpose of rendering communication service to fireboats similar to that now authorized by the (Continued on page 312)

Please Say That You Saw It in RADIO-CRAFT

It's easy to get GIFT MERCHANDISE

In addition to free EQUIPMENT with purchases of

NATIONAL UNION RADIO TUBES and CONDENSERS



RETAIL VALUE . . . \$60.00

87 PIECE ROGERS SILVER SERVICE FOR 8

87 piece service for 8 persons in Good Housekeeping approved tarnish proof, fine wood chest. Encore design X/tra quality silver plate double plated at points of greatest wear. Made and guaranteed by Simeon L. & George H. Rogers Company, famous Oneida silver smiths. Dealer Deposit \$12.00



ELGIN WRIST WATCH

RETAIL VALUE . . . \$37.50

Ladies' ELGIN DE LUXE wrist watch, semi baguette, 17 jewels, 10 K gold filled case, silk cord with ratchet center. Raised figure dial OR man's CRUSADER 8/10 size, 17 jewels, 10 K natural gold filled case. Raised blue figure dial. Leather wrist strap. Dealer Deposit \$11.00

YOU CAN CASH IN TOO

What National Union is doing for others it can do for you. Thousands of completed premium agreements prove the fairness of our proposition. Equipment or premium is obtained immediately on a small down deposit, no time payments to meet or exorbitant interest rates to pay. You get your deposit back as merchandise credit. N. U. can afford to do it because our selling costs are lower. Try it and see why it pays to buy your tubes and condensers the National Union Way.

RC 1139

ASK YOUR JOBBER OR WRITE NATIONAL UNION RADIO CORP. 57 State St., Newark, N. J.

QUALITY—VALUE—GUARANTEE!

WESTINGHOUSE POWER GENERATOR

Manufactured for U. S. Signal Corps

A. C. ELECTRICAL POWER

from a Windmill, from available Waterpower, from your Automobile, from your Motorcycle, from your Bicycle, Footpedals, or Handcrank (for transportable Radio Transmitters, Strong Floodlights, Advertising Signs); operate two generators in series to get 200 V. AC; obtain two phase and three phase AC, etc., etc.

There Are Over 25 Applications

Some of which are: ten 20 Watt 110 Volt lamps, Short Wave transmitter supplying 110 Volts AC for operating "Ham" transmitter Motor Generator, Public Address Systems, Electric Sirens on motor boats, yachts, etc. Camp Lighting, Short Wave artificial "reverberation" apparatus, Television, Airplane for lighting strong search apparatus, Laboratory work, etc., etc.

Generator, as described, including BLUE-PRINT 22 in. and Four-Page 8 1/2 x 12 in. INSTRUCTION SHEETS \$7.90

Send \$2.00 deposit balance C.O.D. Shipping weight 18 lbs.

200Watt.
100 V. AC

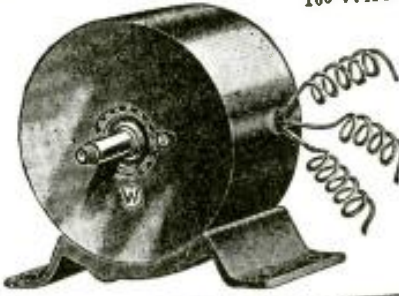

PYRO PANTAGRAPH

Size of box: 12 1/2" x 8 1/2"



\$2.75

VOGUE

This electrical outfit is especially designed for burning designs permanently on Leather, Wood, Cork, Gourd, Bakelite, etc. Simply plug the Pyro-electric pencil in any 110-volt AC or DC outlet and it is ready to be used. Plus outfit furnished as part of equipment and cord furnished as reproduced. By the use of a special Pantagraph included in the outfit, any design may be reproduced either in original, reduced or enlarged form. Outfit consists of three hardwood plaques, one Pantagraph, one bottle of Varnish, one brush, one tracing tip and four-page instruction sheet \$2.75

G. E. PHONOGRAPH MOTOR

Formerly Sold for \$15.00



\$ ONLY 4.95

Variable speed induction type self-starting, 110 volt, 25 to 60 cycle, A.C. with speed control, plug and cord. Speed range from 5 to 200 R.P.M. Can be installed in place of old fashioned, hand winding speed motor. Also ideal for display turn table, and a hundred other uses. These General Electric Motors have never been used and come four packed in original carton. G. E. Electric Phonograph motor as described (with-out turntable) \$4.95

Shipping Weight—12 lbs.

ALL OUR MERCHANDISE IS UNUSED AND SOLD ON A MONEY-BACK GUARANTEE

MICROPHONE AND RECEIVER

This Microphone and telephone headset outfit was built especially for the U. S. Navy Aviation Corps. The outfit to Government specifications. The outfit consists of a low-impedance carbon microphone (transmitter), securely fastened to a metal breastplate, and a set of heavy-duty, low impedance earphones. A specially constructed switch on the back of the breastplate controls the microphone circuit. The earphones are U.S.N. Utah type, attached to adjustable headband. Twenty-eight feet of very heavy weather and waterproof conductor cable is furnished. Current storage battery is the most satisfactory current supply.

U. S. Navy Airplane-type Microphone and Receiver as described \$4.96

Shipping Weight—9 lbs.

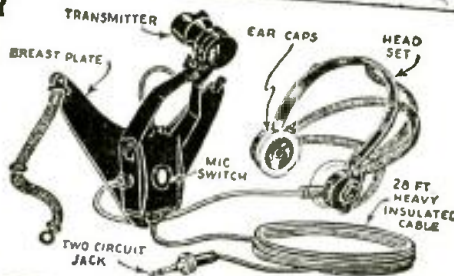

WELLWORTH TRADING CO.

Dept. RC-1139

1915 SOUTH STATE ST., CHICAGO, ILLINOIS

★ ORDER DIRECTLY FROM THIS ADVERTISEMENT ★ WE SHIP 24 HOURS AFTER RECEIPT OF YOUR ORDER, BY EXPRESS COLLECT OR PARCEL POST IF YOU INCLUDE SUFFICIENT POSTAGE.

SERVICING QUESTIONS & ANSWERS

(Continued from page 283)

(A.) With insufficient service data, such as tube voltages in your particular case, the answer to a service problem is difficult to find.

However, you mention that reception from one station is possible but heard with little power and much noise. It would appear that the primary of the 1st audio transformer is burned out and open-circuited. Check also the 30,000-ohm resistor in the detector plate supply circuit for an open-circuited condition.

WHAT IS A "HARMONIC CONVERTER?"

In the December issue of Radio-Craft, this newly-patented circuit will appear as part of an important article on a Hi-Fi 9 Tube Receiver using "Harmonic Conversion."

F.C.C. ALLOCATIONS

(Continued from page 311)

existing rules and regulations of the Commission.

SPECIAL SERVICES

The frequencies which have been allocated to special services have been made available for use by experimental stations for experimentation and research in the development of the radio art. The use by both services will be on a shared basis and it will be necessary that the holders of permits for either service to cooperate to the end that interference may be reduced to a minimum.

Radio-Craft will be interested to hear whether this article has been of material aid to its readers. Write a letter to "Mailbag" if you find this story useful in your work.

RADIO TRADE DIGEST

SERVICEMEN & BCSTRS. IN PROMOTION TIE-UP

(Continued from page 289)

RSA Honors Mfrs.

The Board of Directors of RSA authorized at its June meeting the granting of Honorary Memberships "to those individuals, firms, or corporations who have given their active support and inspiration to the promotion of RSA." Certificates and logotypes will be awarded to these Honorary Members as soon as they are prepared.

The Executive Committee of RSA has awarded Honorary Memberships to the following at this time:

- Aerovox Corporation, New Bedford, Mass.
- Belden Manufacturing Company, Chicago, Ill.
- Crowe Name Plate and Manufacturing Company, Chicago, Ill.
- Lenz Electric Manufacturing Company, Chicago, Ill.
- P. R. Mallory and Company, Inc., Indianapolis, Ind.
- Quam-Nichols Company, Chicago, Ill.
- The Radiart Corporation, East Cleveland, Ohio.
- Radio-Craft, New York, N. Y.
- Raytheon Production Corporation, Newton, Mass.
- Standard Transformer Corporation, Chicago, Ill.
- Thordarson Electric Manufacturing Company, Chicago, Ill.
- United Transformer Corporation, New York, N. Y.
- The Webster Company, Chicago, Ill.

Starts Telly Course

Through the efforts of RSA President George Duvall, RSA has been able to secure for the use of RSA Chapters, a complete course in the servicing and installation of television receivers. While television will not be available for all Chapters for some time, RSA feels that now is the time to prepare the foundations of television training for RSA members.

The plan is to send separate lessons in the course to each Chapter approximately once a month. The Chapter will hold a roundtable discussion and study of the material of the lesson, and each member of the Chapter will answer a prepared questionnaire testing his understanding of the subject studied. These quizzes will be returned to the National Office for grading. Subsequent lessons of the course will be sent to Chapters only after all individual members have turned in their answers to the previous lesson.

In this way, RSA will be able to assure manufacturers that RSA has a trained group of television Servicemen, ready when television arrives in each community.

BIG IMAGES NEEDED TO BOOM TELEVISION?

(Continued from page 289)

tinued, "that small (5 or 6 in.) pictures are doomed."

"Scophony is convinced," Mr. Sagall concluded, "that the future lies with large pictures, and our slogan is 'Television without eyestrain!'"

William Hoyt Peck, leading American exponent of optical scanning systems, was also

Please Say That You Saw It in RADIO-CRAFT

RADIO TRADE DIGEST

queried on this subject by an RTD reporter. Mr. Peck's opinions were similar to those of Mr. Sagall. The American inventor believes that cathode-ray images are extremely good, but that they are not suited to home entertainment in sizes smaller than 12 inches—the largest now available in all save one make of receiver, which employs a tube some two inches larger.

Mr. Peck predicts a day in the not-too-distant future, when home television receivers will produce images not less than 2 by 3 feet, and sell at a cost comparable with present television receivers showing far smaller images.

Proponents of the cathode-ray system, however, are convinced that optical methods will not compete on a basis of price or simplicity.

TUBE COMMITTEE MEETS TO REVIEW SITUATION

(Continued from page 289)

thoroughly analyzed. Definite recommendations will be made shortly after the completion of a national survey. It is the intention of the tube committee to submit their findings to tube manufacturers for their consideration.

Among those present at the meeting were: Arthur Moss, Executive Secretary; Henry Jappe, H. Jappe Co., Boston, Mass.; George D. Barbey, Geo. D. Barbey Co., Reading, Pa.; John Stern, Radio Electric Service Co., Phila., Pa.; Walter Hollenback, Walter D. Hollenback Co., Altoona, Pa.; Charles Ollstein, Sanford Samuel Corp., N.Y.C.; Arthur Stallman, Stallman of Ithaca, N.Y.; H. L. Dalis, H. L. Dalis Co., N.Y.C.; Aaron Lippman, Aaron Lippman & Co., Newark, N.J.

\$'s & No.'s

(Continued from page 290)

PROFIT LOOMED for Hygrade *Sylvania* as net income for first 6 mo. of '39 was over \$343,000. Last year in the same period there was a loss of more than \$88,000.

WONDERFUL WORLD is shown in CBS's latest survey. Radio homes up 14% to 28,000,000; radio sets up 44% to 47,500,000; auto-radios up 56% to 7,000,000.

PHONO-RADIO sales up 710% above last yr. at *Philco*!

BIZ UP 23%, according to excise taxes for 1st 6 mo. of '39. The 5% tax for Jan.-June '39 was over \$2,000,000.

EMPLOYMENT ROSE in April, as compared with preceding year, being up 21.5%; payrolls were up 22.8% in same comparison.

IN CANADA, set sales for 1st 6 mo. of '39 were about 50% ahead of same period in '38.

MAYBE INDUSTRY HAS TURNED THAT CORNER!!

SALES HELPS & DEALS

(Continued from page 290)

Phila., Pa., has inaugurated new information service—a series of Sales Engineering Bulletins, describing advantages of *Philco*
(Continued on following page)

The BIG Features
of the smallest
ELECTROLYTIC CAPACITOR
on the market...



Product of the world's oldest and largest manufacturer of capacitors.

Cornell-Dubilier type BR—famous "Blue Beaver"—smallest 500 working volt Etched Foil Electrolytic Capacitor on the market. Completely eliminates exact duplicate replacement capacitors. Hermetically sealed, safety vented, non-corrosive. Compact, all aluminum tube construction. It's a space saver, a time saver, a money saver. And a mighty worker for you! Available in single and dual capacity combinations at 25, 50, 150, 250, 350, 450 and 500 V.D.C. (Single capacities only at 500 V.D.C.)

For details on complete line of C-D capacitors and Capacitor Test Equipment, send for Cat. No. 175A.

CORNELL-DUBILIER ELECTRIC CORPORATION
1019 Hamilton Boulevard, South Plainfield, New Jersey

NEW RADIO CATALOG

- ✓ **AMATEUR** A complete line of Nationally Advertised receivers, transmitters, mikes, keys, parts, etc.!
- ✓ **SERVICE** Compare all the important makes of test instruments, side-by-side, for the first time in any catalog!
- ✓ **SOUND** equipment for every purpose. From the new one-piece "Orator" to the largest 100-watt sound system for stadiums!

MONTGOMERY WARD
9 Great Mail Order Houses More than 100 Retail Stores

TIME PAYMENTS
Easy terms on Everything!

COMPLETE STOCK
One of the largest in existence!

SAME DAY SERVICE
Your order goes through immediately!

MONEY-BACK GUARANTEE
You take no chances when you order from Wards!



MONTGOMERY WARD & CO.
Dept. RZ-32 Chicago, Illinois
Please RUSH me your FREE Radio Equipment Catalog.

Name.....
Address.....
City..... State.....

Please Say That You Saw It in RADIO-CRAFT

OPPORTUNITY AD-LETS

Advertisements in this section cost five cents a word for each insertion. Name, address and initials must be included at the above rate. Cash should accompany all classified advertisements unless placed by an accredited advertising agency. No advertisement for less than ten words accepted. Ten percent discount for six issues, twenty percent for twelve issues. Objectionable or misleading advertisements not accepted. Advertisements for December, 1939, issue must reach us not later than October 7th.

Radio-Craft • 99 Hudson St. • New York, N. Y.

AGENTS WANTED

300% PROFIT SELLING GOLD LEAF LETTERS FOR store windows; Free samples. Metallic Company, 431 North Clark, Chicago.

BOOKS AND MAGAZINES

WE HAVE A FEW HUNDRED RADIOD ENCYCLOPEDIAS, by S. Gerisback, second edition, originally sold at \$9.98. Book has 352 pages, weight 3 lbs., size 9 x 12 inches. Red morocco—keratol flexible binding. Send \$2.49 in stamps, cash or money order and book will be forwarded express collect. Technifax, 1915 So. State Street, Chicago, Illinois.

\$120.00 ELECTRICAL ENGINEERING COURSE; 60 cloth-bound lessons, \$18.00. Also 10 vol. Elec. & Mech. Eng. Reference Library; large books, leather backs, \$18.00. Harry Ackerson, Box 322, Ramsey, N. J.

CAMERAS & SUPPLIES

BULK FILM: 100 FT. 8MM. \$9.00; DOUBLE, \$1.60; 16 mm., \$1.20. Titles or pictures. Chemicals, outfits. Big catalog for stamp. Hollywoodland Studios, South Gate, Calif.

GENERA FILM IN BULK FOR ALL MOTION PICTURE cameras, 100 feet for Univex, \$1.00; 100 feet double 8mm., \$1.75; 16mm., \$1.35; 400 feet 16mm., \$4.25, postpaid. Sample for stamp. Process with our prepared powders and simplified outfits; 8mm. \$3.75, 16mm. \$4.95. Fromaders, Davenport, Iowa.

EDUCATIONAL COURSES

USED CORRESPONDENCE COURSES AND TECHNICAL Books Bought, Sold, Rented, Exchanged. Free Catalog. Vernon Educational Exchange, Henagar, Ala.

CORRESPONDENCE COURSES AND EDUCATIONAL books, slightly used. Sold, Rented, Exchanged. All subjects. Satisfaction guaranteed. Cash paid for used courses. Complete details and bargain catalog FREE. Send name. Nelson Company, L-242 Manhattan Building, Chicago.

FOR INVENTORS

CASH FOR UNPATENTED IDEAS, STAMP APPRECIATED. Mr. Ball, 9441-J Pleasant, Chicago.

FORMULAS

FORMULAS FOR MAKING INSECTIDES, ANTISEPTICS, Bleaching Solutions, Cements for all Purposes, Stain Removing Preparations, Cosmetics, Depilatories, Dies, Fertilizers, Fire Extinguishing Preparations, Inks, Lacquers, Paints, Plating Solutions, Soaps, Varnishes, Wines and Liquors, and Many Everyday Preparations. Send 10c for each formula. Complete satisfaction or money immediately refunded. L. Felman, 640 Ramapo Rd., Teaneck, N. J.

MISCELLANEOUS

MEXICAN LEGAL MATTERS, AMERICAN ATTORNEY, Box 1736, El Paso, Texas.

RADIO

WE BUY AND SELL USED RADIO TESTING EQUIPMENT. Time payments if desired. Harold Davis, Inc., Jackson, Miss.

8-TUBE CAR-RADIO, WILL SWAP ARVIN CAR SET in good working condition. Has 12-in. speaker (fine tone). Offer camcoid camera or what have you? Doane Bernard, 40 Manning Ave., No. Plainfield, N. J.

ANY RADIO DIAGRAM, 25c. SPECIFY MANUFACTURER, model. Radio magazine free. Supreme Publications, 3727 West 13th, Chicago.

STAMPS

JUBILEES, CORONATIONS, SHIPS, WAR, AIRMAILS. Commemorative, Farleys, Packet 10c. Box 211, Malden, Massachusetts.

TREASURE LOCATORS

TREASURE FINDER (METAL LOCATOR) CUSTOM built by engineer. Great penetrating power. No fancy gadgets. Uses latest radio developments. Simple, inexpensive to operate. Delivery ten days. See Sept. Radio-Craft article for complete information. Price \$55, ready to use; \$40 complete kit, less wood. A. Stuart, 1015 Wilson Avenue, Teaneck, N. J.

TECHNICAL ART SERVICE

DESIGN AND ART SERVICE FOR INDUSTRIAL Marketers. We solve your problems on: product and package design, industrial illustrations, technical drawings and diagrams, phantom, cutaway and explanatory drawings, layouts, lettering, photo retouching, displays, industrial cartoons, etc. Wash photos made from blueprints. We excel in airbrush and color work. Complete catalogs illustrated. 100% satisfaction guaranteed. Suggestions and estimates gladly furnished. Rapid delivery on mail orders. Tee-Art Drafting Service, 228 Charlotte Terrace, Roselle Park, N. J.

RADIO TRADE DIGEST

(Continued from preceding page)

products. Formerly available to distributors, they are now ready for dealers & retailers. Hygrade Sylvania Corp., Emporium, Pa., is using personalized blotters to push prestige with *Newsweek* quote.

SNOOPS & SCOOPS

(Continued from page 291)

the trade any second . . . Television Training School, N.Y.C., graduated its first class of 21 radio and telly technicians . . . Four radio engineers from U.S.S.R. toured the *Areturus* factory in Newark to study U.S. designs and production methods—saw more than 300 types of co.'s tubes being made. . .

RCA Victor has available 6 new recording discs from 6 to 16 ins. with aluminum cores. The co. says they're better than the older models . . . Watch for fireworks in the N.A.B.-A.S.C.A.P. battle. N.A.B. claims excessive charges will hamper industry. . . Several new G.E. sets are ready for frequency modulation stations. . . Excited contributor says well-known mfr. in the sound field will bring out line of amplifiers with lifetime guarantee—a perpetual service to owner from mfr. at no cost except for tubes. . .

Aerovox has capacitor selector and emergency capacitor unit for Servicemen who do refrigerator work—speeds up jobs no end . . . Radio Normandie, French station, is now installing *Finch* transmission equipt.; 100 receivers were also shipped . . . Philco has 13 new models in the "tropic" line . . . Stewart-Warner radio div. will stage campaign for school and college biz., introducing 2 new models for the campus trade. Line includes colored cabinets, school letters and frat insignia. . .

Christmas biz. note! If you've got a clock sideline, G.E. has 19 new models . . . B.F. Hernandez, Maritime Transport Co., erec., says trouble with biz. is America's lack of interest in export. What do YOU think? . . . Flash! Special! Graybar Electric Co. will handle 1940 Majestic radio and telly line in Pittsburgh, Albany, Syracuse & Rochester branches.

Canadian Music Sales Co., Toronto, Ont., Canada, has been appointed sole Canadian agent for *Recoton* cutting & playback needles.

PERSONAL

(Continued from page 292)

R. W. ROLOFF, gen. mfg. mgr. of Hygrade Sylvania's tube plants in Emporium, Pa., and Salem, Mass., has retired after 21 years of service. He was guest of honor at farewell parties in both cities and is holding himself ready for emergency duty.

JOHN F. RIDER won the annual golf tournament of the Sales Mgrs. Club at the Green Meadows Club at Harrison, N. Y., with a score of 78. Second Prize was won by B. OSLER of *Cornish Wire*. Other prizes were won by CHICK WILTBANK of H. H. Eby, & HARRY KALKER of *Sprague Products Co.* Prizes were donated by *Hammarlund Mfg. Co.*, Hygrade Sylvania, *Claro-stat Mfg. Co.* and other cos. On the committee were PAUL S. ELLISON, Hygrade Sylvania; VICTOR MUCHER, *Claro-stat*; JOHN R. RIDER; ARTHUR BERARD, *Ward Leonard*; & WALTER JARLON, *Hammarlund*.

C. H. THORNDARSON, founder and pres. of *Thordarson Elec. Co.* was awarded the Cross of the Icelandic Falcon Order on behalf of King Christian of Denmark. The award is given to persons of Icelandic or Danish ancestry who have made outstanding contribution to world. See pic, pg. 290, for further details.

ERIK ADDE of L. M. Ericsson & Co. of Argentina, spent several days in the *Areturus* factory at Newark, looking over new developments.

EDWARD H. GUILFORD has been appointed Chief Registrar of the *Capital Radio Engineering*

Get This Attractive
DESK LAMP
Absolutely FREE

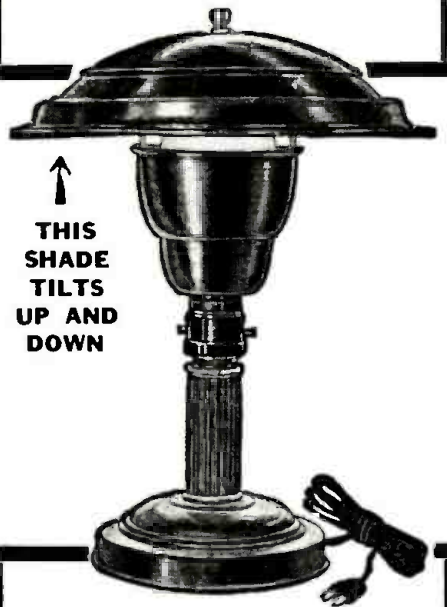

↑
THIS SHADE TILTS UP AND DOWN

JUST THINK OF IT—you can get absolutely FREE, the beautiful desk lamp which is shown above. This lamp is suitable for home, desk, den, office, laboratory, studio or workshop. It is sent to you by the publishers for a one-year subscription to RADIO-CRAFT.

Here Are The Lamp Features!

Constructed of metal with attractive bronze finish. Scientifically constructed to give glareless, diffused light. Helmet-type shade can be tilted to any convenient angle. Stands 13" high and has 10" metal shade. 5-foot rubber insulated cord and plug. Constructed to last for many years.

Clip Coupon—and Mail!

Send your subscription to RADIO-CRAFT for One Year (12 issues) and receive absolutely FREE one of these remarkable desk lamps. New subscribers are accepted or you may extend your present subscription another twelve months. Mail your remittance of \$2.00 (Plus 25c for shipping charges on lamp) to the publishers. (Canada and foreign \$2.75.) You will receive your FREE DESK LAMP by return mail. Use coupon below to enter your subscription.

RADIO-CRAFT

99 Hudson Street NEW YORK, N. Y.

RADIO-CRAFT

99 HUDSON STREET, NEW YORK, N. Y.

Gentlemen: Enclosed you will find my remittance of \$2.00 for which enter my subscription to RADIO-CRAFT for One Year (12 issues). Send me my FREE DESK LAMP. (Canada and foreign \$2.75.) In U. S. add 25c additional to cover shipping charges on lamp.

- () NEW SUBSCRIBER
- () EXTEND PRESENT SUBSCRIPTION

Name

Address

City

(Send remittance by check, money order or un-used U. S. postage stamps. Register letter if you send cash or stamps.)

RC-1139

Please Say That You Saw It in RADIO-CRAFT

Institute. He managed the school's West Coast office for the past 5 yrs.

Officers of the newly incorporated *Auto Radio Dealers Assn.* are MAURICE B. McCULLOUGH, Pres.; GEORGE LEVINE, V-P; GEORGE ALDRICH, Secy.; SID BARRY, Treas. FRED N. DAGAVAR is chairman of the Board, and TRAVIS S. LEVY, an attorney, acts as general counsel.

More than 100 G.E. radio & telly engineers attended a 3-day meeting. Among the "names" present was DR. E. F. W. ALEXANDERSON. Heading the committees were I. J. KAAR & C. A. PRIEST. Others prominent in the affair were DR. W. R. G. BAKER, H. L. ANDREWS, R. C. MUIR, W. C. WHITE, and H. B. MARVIN.

NEW CIRCUITS IN MODERN RADIO RECEIVERS

(Continued from page 282)

input to the detector between 2,850 and 3,150 kc. The I.F. amplifier amplifies signals uniformly in this band.

Just as for the discriminator used in connection with A.F.C. circuits, as the I.F. drops below resonance with the I.F. amplifier, point A of the detector becomes proportionately positive. At resonance (3,000 kc. for this receiver) it is zero with respect to ground and above resonance it becomes proportionately negative. This action is brought about by the phase relationships between C1, L1, L2 and L3 at the various frequencies. As the values indicate, this circuit handles a much wider band than the A.F.C. discriminator and is much more heavily loaded.

(5) FULL AUTOMATIC POWER SUPPLY TRANSFORMER

Pilot models T-1452 and H-1451. Operating instantly when turned on by means of battery power supply, the line power whenever plugged-in will, in a short time, operate a relay so as to switch all circuits onto the power line for operation until the set is turned off.

The circuit, including a new application for a rectifier in receivers, is shown in Fig. 2B. Unusual, is the cathode-to-line connection and the plate-to-receiver connection.

When switches S10 and S11 on the volume control are turned on, there being no current flow through the relay coil X (until the rectifier cathode heats), all switches, S1, S2, S3 and S4 are set to their respective positions "B" (batteries).

Even if the line is not connected, switch S11 will allow operation of the circuit as a battery portable receiver. However, if the line was plugged-in or is plugged-in later, the relay X will be energized on heating of the 25Z6G cathode, and will turn all switches, S1, S2, S3 and S4 to their respective positions "L" (line). The pilot light will then glow, signifying that the batteries are no longer in use and that the set is being entirely supplied from the line.

Note that for the line connection, all of the filaments are operated in a series-parallel group in the rectifier plate circuit. Thus, for either an A.C. or D.C. line supply the filaments will be supplied with D.C.

RADIO THIEVERY

A nation-wide campaign has been organized by the National Association of Performing Artists to stop the racket of the radio program thief who records legitimate programs and sells them for rebroadcasting. As one Senator pointed out there is nothing to prevent the home recordist from making records. It is merely the selling of such recorded broadcasts for commercial purposes which it is desired to prohibit.

JUST OUT SYLVANIA'S BIGGER AND BETTER..

Send for your copy of this big "tube fact" book today

The 1940 Sylvania Technical Manual is bigger and better than ever with a new easy-to-use arrangement. It has 264 pages packed with vital tube information for servicemen, radio technicians, engineers and amateurs.

It gives you complete data and tube diagrams for 344 types of tubes all now listed in numerical-alphabetical order for quicker reference. Operating conditions, characteristics and circuit applications for standard glass tubes, "C" types, "GT" types, Loktal, Metal, Majestic and special types. Full information, too, on Sylvania's complete line of panel lamps.

The new Manual also includes data on special tubes for particular applications in television amplifiers, cathode-ray tubes, etc., with new circuit information and diagrams covering the latest type tubes.

Send the coupon for your copy! This new edition is a bargain at only 35c.



HYGRADE SYLVANIA CORP. Emporium, Pa.

Here is 35c. Please send me a copy of the bigger and better Sylvania Technical Manual.

Name

Address

City

State

Serviceman Experimenter
RC-119 Dealer Amateur

SYLVANIA

Set-Tested Radio Tubes

OPERATING NOTES

(Continued from page 283)

SPARTON 600 SERIES

No reception or loud buzzing preceded by cracking sounds was caused by an open R.F. coil in the R.F. amplifier section. (This coil is easily identified as the one solid-wound unit in the 3rd R.F. tube circuit.)

OLD SONORA SETS

Extreme distortion at low volume with perfect reception at high volume is caused by a slight warping of the voice coil. This trouble can be remedied very simply and permanently by placing two pads of cotton batting under the outside rim of the cone at opposite points. The cotton pads must be small enough to be quite imperceptible and to allow the rim of the cone to be pressed flat on the metal flange, as before.

G. ROGAL

Rogal's Radio Sales & Service

WESTINGHOUSE W-175

Weak to no reception; and volume control very noisy when moved. Tests on the 6A8 circuit show normal plate volts, zero grid current, abnormally high anode grid current, abnormally low screen-grid volts. The trouble is found in the 4-mf. electrolytic which is clamped together with a similar unit, to the underside of the chassis. Remove the one in the 6A8 screen-grid circuit and replace this with a good 4 to 8 mf., dry electrolytic condenser. You will then note with satisfaction that volume is again normal and that every trace of noise has vanished from the volume control.

BEST BUY in Wireless INTERCOMMUNICATING Systems

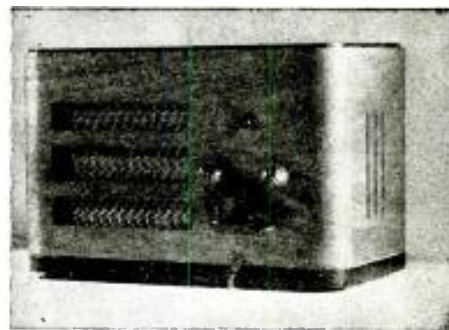

CROSLY CHATTABOX

\$2450 per pair, consisting of TWO COMPLETE MASTER STATIONS.
f.o.b. N.Y.

Complete two-way wireless loud speaking system. Perfect performance. Plug into any 110 volt socket, AC or DC. Equipped with CALL-LISTEN-TALK switch and volume control. Write for information or catalogue.

Sold on 10-day trial with Money-Back Guarantee. Order today.

Jobbers, Dealers and Distributors write for special quantity discount.

AMPLIFIERS - DISTRIBUTORS CORP.
DEPT. R.C., CHRYSLER BLDG., NEW YORK

Sole Distributors of the
CROSLY CHATTABOX

Please Say That You Saw It in RADIO-CRAFT

2 NEW 10c BOOKS

Now Added to Gernsback Series!

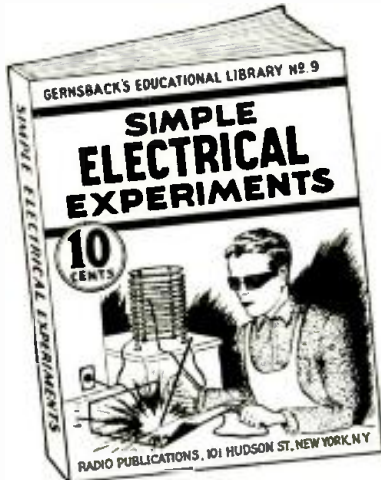

NO. 9—SIMPLE ELECTRICAL EXPERIMENTS

Over 100 interesting and practical electrical experiments are described in this book, covering every branch of electricity—from simple experiments with magnets to high frequency stunts. Among the experiments, all of which are clearly illustrated with special drawings, we find: Experiments with Magnets, Static Electricity, Transformers, Induction, Motors, High Frequency Machines, Switches and Lamps, Polarity Experiments, Dimmers, Etc.

All of the experiments described can be carried out with simple apparatus, most of which can be found about the home. Further, anyone can make them and thus this book becomes at once not only instructive but highly entertaining as well!

RADIO FANS EVERYWHERE—these fine ten cent text books give you an excellent foundation for the study of radio. They are clearly written, profusely illustrated and contain over 15,000 words in each book. You'll be amazed at the wealth of information these books have. Handy for review or reference. **Your money back if you are not pleased!**

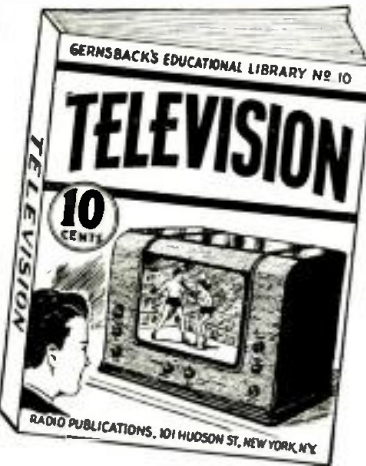

NO. 10—TELEVISION

Every one is asking the question—How does television work? This book explains all of the different systems of television from the simplest to the most complex. It describes in A-B-C style just how the image is scanned, how the scene is picked up by the television camera and broadcast to your home. Various types of television receiving systems are described in easily understood language, and the book is very completely illustrated with dozens of special drawings. The book tells how the accompanying sound for television images is picked up and transmitted and answers hundreds of other questions which the student and layman ask daily.

AND HERE ARE 8 MORE 10c BOOKS

NO. 1—HOW TO MAKE FOUR DOERLE SHORT WAVE SETS

Literally thousands of radio fans have built the famous DOERLE Short Wave Radio Receivers. So insistent has been the demand for these receivers, as well as construction details, that this book has been specially published. Thousands of copies of this book have been bought by short-wave fans. Contains EVERYTHING that has ever been printed on these famous receivers. These are the famous sets that appeared in the following issues of SHORT WAVE CRAFT: "A 2-Tube Receiver that Reaches the 12,500 Mile Mark," by Walter C. Doerle, "A 3-Tube 'Signal Gripper,'" by Walter C. Doerle, "Doerle '2-Tube' Adapted to A.C. Operation," "The Doerle 3-Tube 'Signal-Gripper' Electrified," and "The Doerle Goes 'Band-Spread'".

NO. 2—HOW TO MAKE THE MOST POPULAR ALL-WAVE 1- and 2-TUBE RECEIVERS

This book contains a number of excellent sets, some of which have appeared in past issues of RADIO-CRAFT. These sets have been carefully engineered. They are not experiments. To mention only a few of the sets the following will give you an idea of what you are getting: • The Megadyne 1-Tube Pentode Loudspeaker Set, by Hugo Gernsback • Electrifying The Megadyne. • How To Make a 1-Tube Loud-Speaker Set, by W. P. Chesney. • How To Make a Simple 1-Tube All-Wave Electric Set, by F. W. • How To Build a Four-in-Two All-Wave Electric Set, by J. T. Bernsley, and others.

Not only are all of these sets described in this book, but it contains all of the illustrations, hookups, etc.—each book is up-to-date.

NO. 3—ALTERNATING CURRENT FOR BEGINNERS

This book gives the beginner a foothold in electricity and Radio. Electric circuits are explained. Ohm's Law, one of the fundamental laws of radio, is explained. The generation of alternating current; sine waves; the units—volts, amperes, and watts are explained. Condensers, transformers, A.C. instruments, motors and generators.

Also some practical experiments to perform at home. Simple tests for differentiating between alternating and direct current; how to light a lamp by induction; making a simple electric horn; demagnetizing a watch; testing motor armatures; charging storage batteries from A.C. outlet; testing condensers with A.C.; making A.C. electro magnets; frying an egg on a cake of iron; making simple A.C. motors; many others.

NO. 4—ALL ABOUT AERIALS

This book explains the theory underlying the various types of aerials; the inverted "L," the Doublet, the Doublet-Doulet, etc. It explains noise-free reception, how low-impedance transmission lines work; why transposed lead-ins are used. It gives in detail the construction of aerials suitable for long-wave broadcast receivers, for short-wave receivers and for all-wave receivers. Various types of aerials for the amateur transmitting station are explained. It eliminates once and for all confusion about the type of aerial to choose for best broadcast and short-wave reception. For the thousands of radio fans who wish to know just what type of antenna they should use and why, this book has been published. Experts in radio have found valuable information in this book.

NO. 5—BEGINNERS' RADIO DICTIONARY

Are you puzzled by radio language? Can you define Frequency? Kilocycle? Tetrad? Screen grid? Buffer? Anode? Triode? Diode? Ionization? Joule's Law? Harmonic? Gravity Cell? If you cannot define these very common radio words and dozens of other more technical terms used in all radio magazines and instruction books, you need this book in your library. It's as modern as tomorrow—right up to the minute. It tells you in simple language just what the words that puzzle you really mean. You cannot fully understand the articles you read unless you know what radio terms mean. This is the book that explains the meanings to you. Can you afford to be without it, even one day longer?

NO. 6—HOW TO HAVE FUN WITH RADIO

Stunts for parties, practical jokes, scientific experiments and other amusements which can be done with your radio set are explained in this fascinating volume. It tells how to make a newspaper talk-show to produce silent music for dances—how to make visible music—how to make all of silent radio" units usable by the deafened—how to make toys which dance to radio music—sixteen clever and amusing stunts in all. Any of these can be done by the novice, and most of them require no more equipment than can be found in the average home. Endless hours of added entertainment will be yours if you follow the instructions given in this lavishly illustrated book. Get a copy today by using the coupon below—mail it today.

NO. 7—HOW TO READ RADIO DIAGRAMS

All of the symbols commonly used in radio diagrams are presented in this book, together with pictures of the apparatus they represent and explanations giving an easy method to memorize them. This book, by Robert Elchberg, the well-known radio writer and member of the editorial staff of RADIO-CRAFT magazine, also contains two dozen picture wiring diagrams of simple radio sets that you can build. Every diagram is completely explained in language which is easily understood by the radio beginner. More advanced radio men will be interested in learning the derivation of diagrams, and the many other interesting facts which this book contains. It is also helpful in solving many of the problems of servicemen.

NO. 8—RADIO FOR BEGINNERS

Hugo Gernsback, the internationally famous radio pioneer, author and editor, whose famous magazines, RADIO AND TELEVISION and RADIO-CRAFT are read by millions, scores another triumph with this new book. Any beginner who reads it will get a thorough ground work in radio theory, clearly explained in simple language, and through the use of many illustrations. Analogies are used to make the mysteries of radio as clear as "2+2 is 4". It also contains diagrams and instructions for building simple radio sets, suitable for the novice, if you want to know how transmitters and receivers work, how radio waves traverse space, and other interesting facts about this modern means of communication, this is the book for you!

BOOKS ARE ALL UNIFORM

Every book in the GERNSBACK EDUCATIONAL LIBRARY has 32 pages—with illustrations varying from 30 to 66 in number. Each title volume contains over 15,000 words. Positively radio's greatest book buys! If you do not think these books worth the price asked, return them in 24 hours and your money will be instantly refunded.

RADIO PUBLICATIONS • 101 HUDSON STREET • NEW YORK, N. Y.

RADIO PUBLICATIONS Dept. RC-1139
101 HUDSON STREET, NEW YORK, N. Y.
Gentlemen: Please send immediately, POSTPAID, the book numbers circled below, I am enclosing cents—each book being 10c.

1 2 3 4 5 6 7 8 9 10
NEW NEW

Send FREE listing of 43 new 10c publications.

Name Address

City State

Remit by check or money order—register letter if you send cash or unused U. S. postage stamps.

MAIL COUPON TODAY!

Please Say That You Saw It in RADIO-CRAFT

2-WAY TELLY DEMONSTRATION

(Continued from page 270)

other floor of the hotel in the high-fidelity receiver before him while the television camera picks up his image for a similar receiver there. Microphones provide 2-way communication through the television receiver. To the right is a "jeep" control unit with which the camera is focused and controlled. The television receiver is shielded to make the image more distinct in the glare of the battery of overhead lights.

"JEEP" CONTROL

The "jeep" control mentioned above is identified more exactly as the "Video Cabinet" which constitutes a portion of the RCA model 510-A Television Image Equipment. This equipment is designed for producing a television image having excellent detail in the simplest possible manner. It consists of a studio-type camera, a tripod, a 30-foot camera cable, and the video cabinet.

This "jeep" control contains video amplifiers, a monitoring loudspeaker, an impulse generator, deflection circuits, shading circuits, a small R.F. oscillator, a 12-in. image-monitoring Kinescope, a 2-in. oscilloscope for other monitoring needs, and necessary controls.

The controls are as follows: Iconoscope—horizontal size and centering, vertical size and centering, keystone, bias, and focus; Speed—horizontal and vertical; Kinescope—horizontal size and centering, vertical size and centering, bias, and focus; Oscilloscope—bias, focus, and shading (horizontal sawtooth and parabola, and vertical sawtooth and parabola). There are screwdriver adjustments for stabilization, blanking width, and oscilloscope vertical amplitude.

Just how this concealed but vital Video Cabinet functions is a story which will interest a great many technicians everywhere. We say "everywhere" because the equipment may be operated wherever there is a 110-V. power line available. Each element in this wire-telly control cabinet operates in the following manner.

Video Amplifiers. A voltage amplifier and a line amplifier, the latter designed for feeding a 75-ohm coaxial line. The amplifiers pass a frequency band from 30 cycles to 6 megacycles. Improved amplifier circuits are used throughout to obtain wide response with low noise level.

Synchronizing Equipment. An impulse generator which produces horizontal and vertical blanking impulses. The synchronizing impulses are not standard forms. However, synchronizing signals are produced with which the average television receiver will synchronize if signals are fed properly into the video circuit. If a standard R.M.A. mixed signal is desired, an external synchronizing generator may be employed to feed standard synchronizing signals into the unit.

The synchronizing pulses are used to drive the Iconoscope and monitor Kinescope deflecting circuits (unmixed) through suitable shaping circuits. The width of the vertical blanking and horizontal blanking pulses may be varied. The synchronizing and blanking signals are mixed in the line amplifier for actuating other viewing units.

Monitoring Equipment. A standard 12-in. "black and white" screen Kinescope is mounted in the top of the cabinet for checking the image and for camera focusing. The image may be viewed in a mirror contained in the cabinet lid. The Kinescope is

(Continued on page 319)

RADIO BREVITIES

RSA

DETROIT CHAPTER: Committee on Minimum Service Charges not long ago announced its plan. The principal points are:

(1) Work in the customer's home is limited to simple repairs to exposed parts of the chassis, speaker, antenna, ground, and the testing of tubes.

(2) A service call charge includes removal of the radio set to the shop and return to the customer, as well as a general test and inspection of the installation.

(3) An analysis charge includes a complete analysis to determine all the faults and an estimate of charges for complete reconditioning.

(4) Minimum charges for each common part replacement or service operation, together with charges for work not commonly encountered, are added to the call charge and the analysis charge. The sum of these charges, plus the list price of parts and tubes used, constitutes the charge to the customer.

(5) Any part of the work may be authorized by the customer, but the call charge and analysis charge are to be collected in any case.

(6) "Free Services" are limited wherever possible to the testing of tubes when the tubes are brought into the shop.

In its columns, an issue of Philco Serviceman pointed out that "Television will present one of the biggest fields for expert Servicemen that we have ever had, and it will be truer than ever before that only the trained men will be able to do the work"; and in the article "What about Television?" discusses the Serviceman's angle on modern television.

Newspapers recently headlined an A.P. report thusly: "Czechs' Robot Radios Harass German Police." It seems that in Prague and other Czech cities secret radio transmitters regulated by time devices and working without human attendance were sending phonograph speeches calling upon the Czech population to preserve a solid front. The sets were easily moved from place to place which made locating them even by means of directional loops a difficult problem.

Here's the secret of the "mind-reading" act—The Car That Speaks For Itself—at the Chrysler Motors exhibit at the New York World's Fair. Signals sent out from a short-wave transmitter cause the Mystery Car to execute 35 operations; as many as 4, simultaneously, and all 35 at will!

This car, properly commanded by its interlocutor, can tell you the number of a dollar bill you hold in your hand, or the initials carved on your signet ring, or the nature of the coin you have taken from your pocket—nor does the car have to look at these objects in order to give you the accurate information. In addition, the car at will can open its doors and invite you to get in; it can roll backwards and forwards; wave its windshield wipers; blush at improper questions until the lights in its headlights glow red!

RECORDINGS

"DOCUMENTARY programs covering the New York area alone are a gold mine of information," says Donald Hunter Monro, B.B.C.'s courtesy loan to C.B.S. He

continued: "Columbia's source of television material is limitless."

For the past few months WMCA has been conducting experiments with a mobile recording unit which operates as a newsreel truck in covering events for radio. The system is elaborately termed "documentary radio" by virtue of the fact that it provides a permanent record of events.

Greatest bar to adoption of "documentary radio" is the technical difficulty of making recordings while in motion. Since any sudden jar will upset the sound track, and ruin the transcription, engineers are working on the *gyroscope construction* principle to keep the equipment stable under all conditions.

Against this defect are listed the following 3 advantages which, it is claimed, justify continued research: (1) Documentary radio makes it possible to condense several hours of continuous events into a 15-minute or half-hour program eliminating all uninteresting material. (2) Mobile equipment can be taken into places not possible to reach with ordinary radio facilities. (3) Recordings are more adaptable to program schedules than live broadcasts.

The Papal Coronation broadcasts, for example, were picked up by short-wave from Rome during 5 hours of broadcasting and recorded by WMCA. Reception was particularly poor and in many places, the live broadcast was ruined with unintelligibility and static. This was eliminated in the edited transcriptions made by WMCA and presented several hours later on the air.

The Easter Day program consisted of recordings made from 6:00 A.M., when WMCA's mobile unit attended dawn services at Central Park Mall, until nightfall. Excerpts from many church services as well as interviews along 5th Avenue during the height of the Easter parade were contained in the 15-minute edited show heard that same evening.

The Louis-Galento episode provided one of the highlights of documentary radio. A full day was spent at Louis' camp and recordings made at breakfast with the champion, at ringside with his sparring partners, in the press room with reporters working at copy and at various other places on the training camp premises. The whole show, which took from morning to night to collate, was presented in a 15-minute period.

A bright idea went for nought, in France, when a Paris judge refused to listen to recordings made by a Mr. Pierre Amas offered in evidence that his wife nagged him privately but in public was "sweet as could be." The judge contended the authenticity of the discs could not be proved.

SHORT WAVES

Short-wave, non-commercial station W1XAL, Boston, recently started an air course on television. A booklet entitled "Modern Radio Course" is available, at nominal cost, to supplement the lectures by Dr. C. Davis Belcher. The course is most extensive and the 88-pg. booklet is recommended to everyone who has enough initiative to want to learn the elements of modern television, free, via W1XAL. Dr. Belcher keeps close at hand, near the mike, a master blueprint, and thousands of students all over the world using their printed texts regularly follow him as he traces the new telly circuits!

Multi-Speaker Installations



Wright-DeCoster wall mounting cabinet and speaker combinations.

- Low in Cost
- Excellent in Appearance
- Tamper Proof
- Finished in either taupe suede or fine brown crackle.

See your nearest distributor or write direct for information.

WRIGHT-DECOSTER, Inc.

2251 University Ave., St. Paul, Minn.
Export Dept.: M. Simons & Son Co., New York
Cable Address: "Simontrics"

Canadian Representatives:
Wm. F. Kelly Co., 1207 Bay St., Toronto, Ontario
Taylor & Pearson, Ltd., Edmonton, Alberta

Have You Seen...

The NEW Meissner 1939-40 Catalog—just off the press that describes in its 48 pages over 800 new, different and improved Radio and Television items including:

- TELEVISION KIT for \$139.50—pages 4 and 5
 - 9-TUBE "TRAFFIC" SCOUT—page 8
 - PRESELECTION and 5 and 10 METER CONVERTER—page 9
 - PORTABLE BATTERY OPERATED KIT—page 19
 - SIGNAL CALIBRATOR AND AUTOMATIC ANTENNA SELECTOR—page 22
 - DELUXE SIGNAL SHIFTER—page 23
 - ADAPTER KITS AND 6 PUSH BUTTON TUNER—pages 24-26
 - POWER RELAY AND ANTENNA CHANGE-OVER RELAY—page 29.
 - IMPROVED PLASTIC I. F. TRANSFORMER for \$1—page 33
- and hundreds of other up-to-the-minute developments in radio and television.

FREE!!! To all service men, amateurs, hams, experimenters. Mail coupon below today for your copy.

SEND 50 CENTS for Meissner's "NEW GUIDE TO RADIO AND TELEVISION," a complete, scientific instruction book and Trouble-Shooter's Manual for Kit Builders and Operators. Fully illustrated. 168 Pages.



Meissner Mfg. Co.,
Mt. Carmel, Ill.—Dept. RC-11

Mail me Meissner's New 1939-40 Catalog.
 Enclosed find 50 cents for instruction Book.

Name

Street

City State

Please Say That You Saw It in RADIO-CRAFT

For Better Servicing - - For Bigger Profits - - Use Gernsback Manuals and Books!



SINCE 1931 Servicemen have been buying more GERNSBACK OFFICIAL RADIO SERVICE MANUALS year after year. The authentic material, easily accessible diagrams and complete service data make them invaluable to dealers and radio Servicemen. *Without a Gernsback Service Manual at the repair job, there's time and profit lost.* Your service kit or laboratory is incomplete without all the GERNSBACK OFFICIAL RADIO SERVICE MANUALS. There are GERNSBACK MANUALS for servicing auto-radios, also refrigeration and air conditioning equipment.

- VOLUME 7 OFFICIAL RADIO SERVICE MANUAL**
Over 1,800 Pages • Over 3,000 Illustrations • Stiff, Leatherette, Looseleaf Covers • Size 9 x 12 Inches • Net Weight 10½ lbs. **\$10.00**
- 1936 OFFICIAL RADIO SERVICE MANUAL**
Over 1,200 Pages • Over 2,500 Illustrations • Stiff, Leatherette, Looseleaf Covers • Size 9 x 12 Inches • Net Weight 8 lbs. **\$7.00**
- 1935 OFFICIAL RADIO SERVICE MANUAL**
Over 1,000 Pages • Over 3,000 Illustrations • Flexible, Leatherette, Looseleaf Covers • Size 9 x 12 Inches • Net Weight 3¾ lbs. **\$7.00**
- 1935 OFFICIAL AUTO-RADIO SERVICE MANUAL**
Over 240 Pages • Over 500 Illustrations • Flexible, Leatherette, Looseleaf Covers • Size 9 x 12 Inches • Net Weight 1¾ lbs. **\$2.50**
- 1934 OFFICIAL RADIO SERVICE MANUAL**
Over 400 Pages • Over 2,000 Illustrations • Flexible, Leatherette, Looseleaf Covers • Size 9 x 12 Inches • Net Weight 2¼ lbs. **\$3.50**
- 1932 OFFICIAL RADIO SERVICE MANUAL**
Over 1,000 Pages • Over 2,000 Illustrations • Flexible, Leatherette, Looseleaf Covers. Size 9 x 12 Inches • Net Weight 4¼ lbs. **\$5.00**
- OFFICIAL REFRIGERATION SERVICE MANUAL**
(Volume 11)
Over 352 Pages • Over 300 Illustrations • Flexible, Leatherette, Looseleaf Covers. Size 9 x 12 Inches • Net Weight 1½ lbs. **\$5.00**
- OFFICIAL AIR CONDITIONING SERVICE MANUAL**
Over 352 Pages • Over 600 Illustrations • Flexible, Leatherette, Looseleaf Covers. Size 9 x 12 Inches • Net Weight 2¼ lbs. **\$5.00**

To order these famous Manuals, see or write to your jobber or favorite mail order house. If more convenient, mail coupon directly to publishers.

Many New Books Have Been Added to RADIO-CRAFT LIBRARY SERIES

Get into the swing of reading instructive, authoritative books on technical subjects—radio, air conditioning and refrigeration. It's the easiest, quickest and most inexpensive way to improve your knowledge on these topics. In this series, popularly known as the RADIO-CRAFT LIBRARY SERIES, are all the titles necessary to your personal advancement. Only by careful study of these enlightening books, can you gain adequate experience in fields of radio, air conditioning and refrigeration. Each book is uniform. The volumes measure 6 x 9 inches—contain 64 pages, and have stiff, flexible covers. PRICE 50c PER BOOK. All books are sent to you postpaid.

Here Are The Titles:

- | | |
|---|---|
| Book No. 2
MODERN VACUUM TUBES | Book No. 18
POINT-TO-POINT RESISTANCE ANALYSIS |
| — | — |
| Book No. 6
BRINGING ELECTRIC SETS UP-TO-DATE | Book No. 19
PRACTICAL RADIO KINKS AND SHORT CUTS |
| — | — |
| Book No. 13
ABC OF AIR CONDITIONING | Book No. 20
THE CATHODE-RAY OSCILLOSCOPE |
| — | — |
| Book No. 14
POCKET RADIO GUIDE | Book No. 21
BREAKING INTO RADIO SERVICING |
| — | — |
| Book No. 15
ABC OF REFRIGERATION | Book No. 22
NEW RADIO QUESTIONS AND ANSWERS |
| — | — |
| Book No. 16
PRACTICAL RADIO CIRCUITS | Book No. 23
PRACTICAL PUBLIC ADDRESS |
| — | — |
| Book No. 17
SERVICING WITH SET ANALYZERS | |

EACH BOOK IN THIS SERIES—50c

RADCRAFT PUBLICATIONS, Inc.
89 HUDSON STREET NEW YORK, N. Y.

RADCRAFT PUBLICATIONS, Inc., 99 HUDSON ST., NEW YORK, N. Y.
Gentlemen: Enclosed find my remittance of \$..... for which send me, POSTPAID, the Manuals or Books indicated below by a cross (x) in the panel.

() Volume 7 @ \$10.00 () 1936 Manual @ \$7.00 () 1935 Manual @ \$7.00
() 1935 Auto-Manual @ \$2.50 () 1934 Manual @ \$3.50 () 1932 Manual @ \$5.00
() Refrigeration Manual (Vol. 2) @ \$5.00 () Air Conditioning Manual @ \$5.00

RADIO-CRAFT LIBRARY SERIES @ 50c EACH
Circle book numbers wanted: 2 6 13 14 15 16 17 18 19 20 21 22 23

Name Address

City State

(Send remittance in form of check or money order; register your letter if you send cash or unused U. S. Postage Stamps.) RC-1139

Please Say That You Saw It in RADIO-CRAFT

FREE- REAL ELECTROPLATING OUTFIT



**Now—
You Can ELECTROPLATE
EASILY WITH A BRUSH**

SOMETHING new for radio men—something which gives you the opportunity to make additional profits—or to improve your type of service. Here's an **ELECTROPLATING KIT** amazingly simple to operate—you just Electroplate with a Brush!

NOT A TOY!

Electroplate for profit, hundreds of things in the household—ashtrays, fixtures, water faucets, worn brackets, door knobs, musical instruments, jewelry and silverware and other articles. It's an indispensable piece of equipment—plate articles in hotels, apartments, office buildings, medical and dental offices, factories, schools, laboratories, etc. Exactly the same outfit (but larger) is used professionally by electricians, radio service men, automobile repair shops, etc. Requires one single dry cell 112-volt battery to operate.

You can electroplate tarnished receiver parts, escutcheons, contacts, worn radio parts and accessories, and display chassis. Put the **REAL ELECTROPLATING KIT** to use immediately—make it the most useful article in your shop or laboratory. And you can get it absolutely **FREE** (except for slight mailing cost).

Subscribe today to **RADIO-CRAFT** for One Year (12 issues) and receive absolutely **FREE** this **ELECTROPLATING KIT**. New subscribers are accepted or extend your present subscription twelve months. Mail remittance of \$2.00 (plus 10c for shipping charge on kit) to the publishers. (Canada and foreign \$2.85). You will receive your **FREE, REAL ELECTROPLATING OUTFIT** by return mail. Use coupon below to enter subscription.

RADIO-CRAFT

99 Hudson Street New York, N. Y.

RADIO-CRAFT RC-1139
99 Hudson Street, New York, N. Y.

Gentlemen: Enclosed find my remittance of \$2.00 for one year, 12 issues. Send me **FREE, ELECTROPLATING OUTFIT** (Canada and foreign \$2.85). In U. S. add only 10c additional to cover shipping charges on kit.

New Subscriber Extend Present Subscription

Name

Address

City State

(Send remittance by check, money order or unused U. S. Postage stamps. Register letter if you send cash or stamps.)

2-WAY TELLY DEMONSTRATION

(Continued from page 316)

provided with its own controls for speed, brightness and contrast. A 2-in. oscilloscope is used for setting levels and adjusting the image. Either 1 line or 1 frame may be viewed.

Correction Circuits. Shading circuits for setting an even illumination over the image area are contained in the cabinet with controls on the top. Keystone correcting circuits are included and may be varied by means of a control.

R.F. Oscillator. A low-power oscillator-amplifier is included with a video modulator for driving receivers through a suitable concentric cable.

Power Supply. Several carefully-designed power supplies and filters are included. The amplifier plate supply is provided with a regulating system. Iconoscope second-anode supplies and Kinescope anode supplies are furnished by a rectifier.

Sound System. No sound system is ordinarily included, but space is provided for mounting a public address amplifier on the inside of the cabinet. A monitor loudspeaker is supplied mounted in the cabinet behind a cloth grille on the lower front panel. A pressure-type microphone is well suited for pick-up purposes. A separate sound system may also be employed with only the monitoring loudspeaker in the cabinet.

Additional Monitor Viewing Receivers. Standard television receivers can be fed directly from the R.F. output of the image unit. These can be supplied in 5-, 9-, or 12-in. sizes. If desired, a special 12-in. panel-mounted monitor with extra-wide-frequency-response characteristics may be supplied for operation from the video circuits. The receivers should be connected to the image unit by a coaxial line with proper termination. A lead-covered twisted-pair can be used for the audio connections by connecting into the receiver; or another R.F. oscillator may be added.

APPLICATIONS

The Television Image Equipment (which includes the Video Cabinet) may be used to demonstrate television receivers when regular service is not available. Thus this equipment fills a wide range of usage—and although it is comparatively simple from the equipment standpoint and designed for use with a single camera, yet it will produce a television image which compares favorably with that obtained from more elaborate rack equipment for wire-television.

Also, the Television Image Equipment is ideal for producing television images for experimental test, display or educational purposes. It is simple, compact and easy to operate. A Monoscope may be used in place of the Iconoscope for producing a fixed pattern to test receivers.

MAILBAG

(Continued from page 275)

closed photograph (Reproduced on page 275. —Editor) will give you some idea of the style of the equipment which we have been constructing to date. The one illustrated employs 13 valves (English term for tubes.—Editor), and consists of a standard Stromberg-Carlson 8-valve, dual-wave receiver. This receiver normally employs push-pull, 42-type output tubes, but the output was modified slightly to use these tubes as triode-drivers for the power stage.

(Continued on following page)

Please Say That You Saw It in RADIO-CRAFT

Save Money!

With the

RADOLEK RADIO PROFIT GUIDE!

164
PAGES

**EVERYTHING IN RADIO
AT LOWEST PRICES!**

Radolek offers you the **MOST** for your money! **Lowest Prices!** **Best Quality!** **Highest Values!** **Most Complete Stock!** **Fastest Service!** Send for your **FREE** copy **NOW!**

OVER 15,000 REPAIR PARTS

The world's most complete stock of radio repair parts and exact duplicate replacements. All leading brands. All guaranteed. **Lowest Prices!**

COMPLETE TUBE SELECTION

All types, RCA, Sylvania, Raytheon, Philco, etc. Includes Kellogg, special Majestic types and transmitting tubes. Complete selection.

NEWEST TEST INSTRUMENTS

The most complete line ever displayed in any catalog. All leading makes. Latest improved models at lowest prices.

GREATEST RADIO VALUES

A huge selection of money-saving set bargains! New Hamo-Radio combinations. Automatic tuning sets. Beautiful cabinets. New "Ham" receivers and equipment.

EVERYTHING FOR AUTO RADIO

Complete auto radio section. Includes vibrator replacement guide, new auto aeriels, custom panel control plates for all autos, newest Auto Sets.

COMPLETE P. A. SELECTION

New 1940 public address amplifiers from 5 to 100 watts. Complete P. A. Systems for permanent, mobile and portable installations. **Best values!**

NEW ELECTRICAL APPLIANCES

Extra profits for you! Standard Brand Electric Irons, Stoves, Heaters, Percolators, Waffle Irons, Vacuum Cleaners, Trains, Clocks, Mixers, etc., at lowest prices!



Mail Coupon Catalog!

The RADOLEK Co.

601 W. Randolph, Chicago,
Dept. C-35

Send the 1940 Radolek Radio Profit Guide **FREE.**

Name

Address
Serviceman? Dealer? Experimenter?

RIMCO DYNALYZER MODEL 701 THE FIRST COMPLETE DYNAMIC TESTER

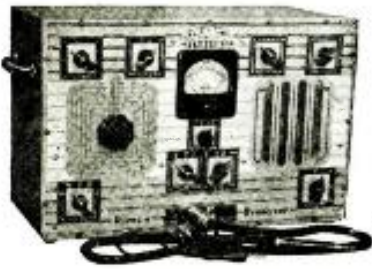

THE Rimco DYNALYZER is the only complete dynamic tester which also includes the following PLUS features:

1. Built-in dynamic speaker for "listening-in" on signals at any point in a radio from antenna to voice coil.
2. Antenna and ground terminals enabling substitution for R-F as well as other radio sections.

Mail Today!

3. Electronic voltmeter enabling user to see as well as hear signal "gain-percentage" and measure all DC voltages in radios—measures resistances from 1 ohm to 10 megohms without batteries.

- SIMPLE
- FAST
- USEFUL

Write TODAY for literature!

Floyd Fausett, President,
Radio Instruments Mfg. Company,
629 W. Monument Street,
Jackson, Mississippi, U. S. A.
Please send me complete information on the
new Rimco DYNALYZER, Model 701.

Name

Address

City State

Please Print

Coming Soon - RIMCO'S NEW MODEL 89 TUBE TESTER

● REMOTE CONTROL FOR A. C. RADIOS ●



A wireless remote control that tunes ANY electric set! Without wires to your radio! From distances up to 20 ft. you can tune your 6 favorite stations by just touching a button! Change the volume, too. Just plug the Remote Control in any electric outlet. Handsome cabinet. Size: 4 1/2 x 6 1/2 x 8 3/4 inches. Complete with 3 tubes stations. For 110-120-volt, 50-60 or 25-cycle A.C. or D.C. Shwg. wt., 6 lbs.

List Price \$20—Your Price **\$4.88**
ARROW SALES CORP., 619 W. Randolph, Chicago, Ill.
Send for 24 page catalog.

RADIO ENGINEERING

RCA Institutes offer an intensive course of high standard embracing all phases of Radio and Television. Practical training with modern equipment at New York and Chicago schools. Also specialized courses and Home Study Courses under "No obligation" plan. Catalog Dept. RC-39.

RCA INSTITUTES, Inc.
A Radio Corporation of America Service
75 Varick St., New York 1154 Merchandise Mart, Chicago

(Continued from preceding page)

The power stage was required to drive 14/8" permanent-magnet, moving coil speakers normally rated at 5 watts. We found, however, that 1 1/2 watts was sufficient for the various classrooms, and we adopted a power amplifier consisting of 4 type 50 valves in parallel push-pull, the power supply being provided by one 5Z3 valve. The 50's were fed into an output transformer especially constructed to match 14/500-ohm lines in parallel. Each speaker was individually switched on the control panel by means of a platinum-contact, lever-type switch which automatically substituted a load resistance when the speaker was switched off.

A rectifier-type output meter was employed across the output transformer so that all programmes could be brought up to pre-determined level, individual volume controls being fitted to each speaker. Further modifications were carried out in the receiver section to provide for the pre-amplifier stage for the piezo-crystal D104 microphone, while the pickup was fitted into the normal pickup terminals on the receiver chassis. A monitor speaker was installed at the top of the rack, so that the various programmes could be monitored without difficulty, this speaker being cut off automatically as the microphone was switched in.

This equipment was installed at the Kalgoolie Central School. Kalgoolie is a very active goldmining district situated inland from Perth about 375 miles. This distance made daylight reception of broadcast stations rather difficult, in addition to which a very high noise level was created by the local electrical interference. To off-set this trouble as much as possible a standard L-type aerial was erected on two 70-foot masts 100 feet apart, the lead-in being of the transposed type. The installation being located as it was in a D.C. area it was necessary to employ a rotary converter to provide a 250-V., 40-cycle A.C. supply to operate the equipment.

A smaller equipment built on the same lines was installed at private school in Kalgoolie, the design being similar but the equipment in this case was only required to operate 6 extension speakers, and in this instance I installed a standard A.C./D.C. receiver using push-pull pentode output tubes capable of providing an output of 10 watts, with 200 volts D.C. on the plates. A similar aerial to that described was also employed in this case.

Unfortunately our scope for installations of this description is rather limited in this State, but we are gradually making progress, and educating the various school committees to the advisability of installing an equipment especially constructed for this purpose.

We trust that you will find these remarks of interest, and we have no objection to your publishing the photograph in your magazine should you desire to make use of it. Of the various school equipment which has been illustrated in *Radio-Craft* from time to time we have not seen one which approaches our own in design. For this reason we feel that the illustration would be of interest to you.

J. W. LOVE,
Chief Engineer, Radio Dept.,
Musgronis Limited,
Perth,
Western Australia.

Radio-Craft has world-wide distribution and we feel sure many other overseas readers know of unusual or improved applications of public address, radio, or electronic equipment which would make equally as interesting reading as Mr. Love's letter. How about it, fellows?—Editor

Index to advertisers

A	
Aerovox Corporation.....	302
Allied Radio Corporation.....	293
American Microphone Company.....	301
Amperite Corporation.....	Inside Front Cover
Amplifier Co. of America.....	308
Amplifiers Distributors Corp.....	315
Arcturus Radio Tube Company.....	303
Arrow Sales Company.....	320
Theo. Audel & Company.....	298
B	
Burstein-Applebee Company.....	300
C	
Capitol Radio Engineering Inst.....	298
Central Radio Laboratories.....	294
Classified Section.....	314
Cornell-Dublier Elec. Corp.....	313
Coyne Electrical School.....	296
D	
The Data Print Company.....	300
F	
Foto-Craft Magazine.....	304
G	
Goldentone Radio Company.....	308
H	
Hammarlund Mfg. Company.....	300
Hygrade Sylvania Corporation.....	315
I	
International Correspondence Schools.....	294
International Resistance Company.....	259
L	
Lancaster, Allwine & Rommel.....	302
Lincoln Engineering School.....	302
M	
Meissner Mfg. Company.....	317
Modell's.....	298
N	
National Plans Institute.....	302
National Radio Institute.....	257
National Schools.....	309
National Union Radio Corporation.....	311
New York Y.M.C.A. Schools.....	306
R	
Radio & Tech. Publishing Co.	Inside Back Cover
Radio Circular Company.....	298
Radio City Products Company.....	309
Radio Instruments Mfg. Co.....	320
Radio Publications.....	316
Radio Servicemen of America.....	310
Radio Wire Television, Inc.....	299, 304
Radolek Company.....	319
RCA Institutes, Inc.....	320
Readrite Meter Works.....	305
Remington Rand, Inc.....	306
S	
Solar Manufacturing Company.....	309
Speak-O-Phone Recording & Equip. Co.....	305
Sprague Products Company.....	306
Sprayberry Academy of Radio.....	307
Superior Instruments Company.....	293, 297
Supreme Instruments Corporation.....	301
T	
Technifax.....	308
Triplett Elec. Instrument Co.....	Back Cover
The Turner Company.....	308
W	
Montgomery Ward & Company.....	313
Wellworth Trading Company.....	312
Wright-DeCoster, Inc.....	317

(While every precaution is taken to insure accuracy, we cannot guarantee against the possibility of an occasional change or omission in the preparation of this index.)

Please Say That You Saw It in RADIO-CRAFT

Which of these 3 GHIRARDI RADIO "CLASSICS" do You Need Most?

RADIO FUNDAMENTALS

made Easy!

YOU CAN LEARN AT HOME
the Basic Fundamentals
of RADIO and TELEVISION
from this GREAT BOOK

Fit yourself for a radio job quickly, easily, economically—with Ghirardi's famous home-training course, complete in this handy, one-volume edition. You will be absolutely amazed at the speed and ease with which you can learn Radio using Ghirardi's popular short-cut method. The whole fascinating science of Radio and Electricity just seems to unroll before your eyes as you progress rapidly from page to page. Without previous training, with no mathematics to worry you, you will find yourself in less time than you imagined possible, thoroughly grounded in the fundamentals, all ready to hold down a good-paying position in this great profession!

Complete Self-Study Course

Ghirardi's Course gives you practical self-instruction, for you get a thorough basic education, not just Radio alone, but also in Electricity, Sound, Television, Cathode-Ray Tubes, Photoelectric Cells, and many other brilliant fields. Altogether you get 36 separate self-study courses, each equivalent to a complete text-book in itself—all bound together in form this one big book that is yours to read and own for the phenomenally low price of only \$4. Everything you want to know is right here in one source—a complete radio library for study and reference.

GHIRARDI makes it Crystal-CLEAR

Each and every point is made so plain and precise, each description and explanation so simple and easy to understand that you will find no radio problem too "difficult" or over your head. Ghirardi's A.G. style of writing, with the helpful illustrations (508 of them) and the 858 self-testing Review Questions make your main training a constant pleasure, a profitable pastime!

36 VOLUMES IN 1

RADIO, ELECTRICITY and SOUND Complete Plus Many Other Valuable Special Features are covered in these 36 Big Chapter-Sections, 972 Pages, 508 Schematic Diagrams, Charts and Photos, 856 Review Questions.

- | | | |
|--|---|---|
| 1. Radio Broadcasting System. | 14. Electrical Measuring Instruments. | 24. Audio Amplification. |
| 2. Sound, Speech and Music as Related to Broadcasting. | 15. Radio Transmission System. | 25. Loud Speakers. |
| 3. Electric Theory. Electric Current. | 16. The Receiving Station. Detection with Crystals. | 26. The Battery Operated Receiver. |
| 4. Elec. Units. Ohm's Law. Resistance. | 17. Elementary Study of the Vacuum Tube. | 27. The Power Supply Unit. |
| 5. Electrical Circuits. Batteries. | 18. Vacuum Tube Characteristics. | 28. Electric Receivers. |
| 6. Magnetism. | 19. Construction Features of Vacuum Tubes. | 29. Automobile and Aircraft Receivers. |
| 7. Electromagnetism. Induction. | 20. Vacuum Tube Applications and Photoelectric Cells. | 30. Phonograph Pick-ups and Systems. |
| 8. Electromagnetic Induction. | 21. Radio Frequency Amplification. | 31. Short Wave. |
| 9. Inductance and Inductors. | 22. Superheterodyne Receivers. | 32. Vacuum Tube Applications and Photoelectric Cells. |
| 10. Capacitance and Condensers. | 23. Design of R.F. Amplifiers and Tuning Instruments. | 33. Television. |
| 11. A.C. Circuits. | | 34. The Antenna and Ground. |
| 12. Electric Filters. | | 35. Testing and Servicing. |
| 13. Electrical Measuring Instruments. | | 36. Sound Films. |

Used by Radio Schools Everywhere

Because it explains everything so clearly, Ghirardi's RADIO PHYSICS COURSE is used and praised by more radio schools and students than any other radio text-book in the world. Thousands of successful radio men today owe their start to Ghirardi. He helped them to get into this good-paying profession the "easy" way. Today the same opportunity is open to you. This is your Big Chance at this amazing Low Price! Grab it now!

Get Started—Rush Coupon Now!

There's no need to put off your Radio training another day. For not only is the famous Ghirardi course the most economical you can find, but you don't have to risk a penny to find out if this is what you've been looking for! Here's what you do: fill out the coupon and get it mailed at once. Then, when you get the book, keep it and read it five whole days at our risk. If not fully satisfied, return the book undamaged and your money will be immediately refunded. You see, you can't lose! Your new Radio Career is about to begin—the moment you mail that coupon. Don't delay it—MAIL IT!

RADIO & TECHNICAL PUBLISHING CO.,
45 Astor Place, New York, Dept. RC-119

Enclosed find \$4 (\$4.50 foreign) for my copy of Ghirardi's "RADIO PHYSICS COURSE" with your 5-day Money-Back Guarantee.

NAME

ADDRESS

CITY STATE

Please send me free descriptive literature about "RADIO PHYSICS COURSE."

**USE IT
5 DAYS
-OUR RISK
Money-Back
Guarantee**

**NOW I KNOW
WHAT I'M DOING!**

With Ghirardi's
Servicing Books
I Do My Service Work
Quicker and Better



The "JOB DATA" The "THEORY"

Mr. Serviceman—here's that "dope" you've been wanting hours of precious time trying to dig out of your old tipfiles—all completely compiled, classified and indexed in 1 handy source—the only book of its kind anywhere. What a goldmine! Just imagine—one section of the book contains thousands of "Case Histories" clearly outlined right here at your finger tips for split-second use. If your time is worth anything at all, this part of the book alone is the most valuable piece of "must" equipment for your shop. Cut out guess-work, cut out "head-aches", cut out many time-wasting trial tests. Get smart and use Ghirardi's speed-demon time-saver! It's a Trouble-Shooter's Paradise! Use it once—and you'll use it profitably on every job. Get your copy today!

3,313 Case Histories

- Case Histories—Trouble Symptoms and Remedies for 3,313 sets, exhibited from actual Service Records—a world's record for quantity and authority!
- IF Peaks—15,000 Listings for Alignment of all Superhets, old and new.
- Auto-Radio—Gear Ratios and Dial Directions of Tuning Controls of all sets. Installation and Calibration Systems Data for all cars; Special Interference Elimination Instructions; Electrical Wiring Diagrams, etc.
- Other Data—Over 100 more pages of data, including quick Trouble-Shooting Charts; Servicing Home Recorders; Servicing Intercommunicators; Trade Directories; Charts and Tables on Tubes, Filters, Transformers, etc.
- 518 PAGES • 134 Illustrations • Standard Manual Size (8 1/2 x 11) • Fabricoid-bound • \$3.00.

Theory from A to Z:

- Test Equipment—420 pages of Theory, Descriptions, Diagrams of all Commercial Instruments, How They Work, Construction Data, etc.
- Trouble-Shooting—254 pages of short-cut methods for tracking down all types of different receiver troubles.
- Repairing—184 pages of advanced "Factory Methods" for Superhet Alignment, Interference Elimination, Rebuilding of Receiver Parts, etc.
- Special Problems—442 takes an Auto-Radio Installation and Servicing; Servicing All-Wave Sets, High Fidelity Sets, AVC and QAVC circuits; setting and Advertising, etc.
- 1300 PAGES • 706 Illustrations • 720 Review Questions • 766 Topics • \$4.00.

RADIO Trouble Shooter's HANDBOOK

MODERN Radio SERVICING

\$6.50 For BOTH BOOKS
Special Combination Price. Use the books 5 days at our risk. You can't lose! Order Now!

Money Back Guarantee

Mail Today!

Radio & Technical Publ. Co.,
Dept. RC-119, 45 Astor Place, N. Y.
Enclosed find payment for, and rush to me postpaid with 5-Day Money-Back Guarantee:
 MODERN RADIO SERVICING at \$4. (54.50 foreign)
 RADIO TROUBLE-SHOOTER'S HANDBOOK at \$3. (53.50 foreign)
 BOTH BOOKS at \$6.50 Special Combination Price (\$7 foreign)

NAME

ADDRESS

CITY STATE

Please send me FREE descriptive literature.

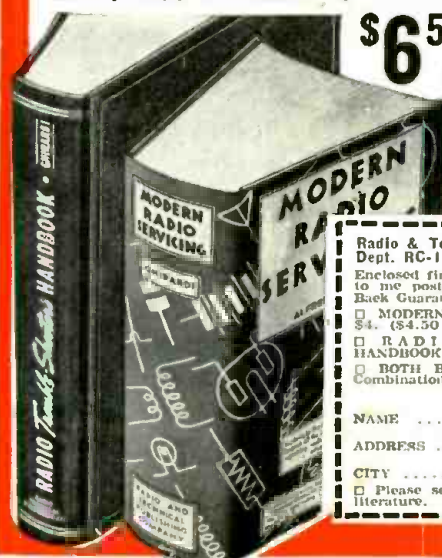

This
TUBE TESTER
 has
Everything

MODEL 1213 . . . \$22.00 NET



TRIPLET

THE NEW FOLDEX TUBE CHART

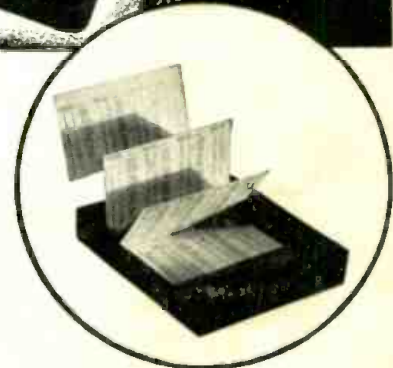

A folding "card-index" system, giving quick and complete tube data with the additional advantage of new tube supplements (on government post cards) mailed free to registered owners.

MODEL 1612

An Impressive Counter Tube Tester you will want to own . . . with a 7-inch RED • DOT Lifetime Guaranteed Instrument. Illuminated Speed Roll Chart shows 36 tube settings at a single glance . . . entire chart can be covered in less than 10 seconds. Tester provides for future filament voltages—20 steps from 1 to 110. Contains all tube sockets, including Loctal, Bantam Jr. and the high voltage series (including the 117Z6G).



Dealer Net Price . . \$29.84

MODEL 1213 contains all the sockets to test present-day tubes, including Loctals, the new Bantam Jr., the High Voltage series recently announced (including the 117Z6G), gaseous rectifier and ballast tube continuity tests. Will not deactivate 1.4 volt or other type tubes—a positive assurance with any current Triplet Tube Tester. Filament Voltages from 1 to 110 . . . Neon shorts test . . . Separate line voltage control meter. With RED • DOT Lifetime Guaranteed Instrument—the Sensation of the Season. Model 1213 . . . Complete with Accessories . . . \$22.00 Dealer Net Price.

MODEL 1200-A

Volt - Ohm - Milliammeter. Separate AC and DC Instruments in tilting twin case, accuracy of each within 2%. 10 AC and DC Voltage ranges; four Direct Current ranges; high and low resistance ranges. With RED • DOT Lifetime Guaranteed Instrument . . .



Dealer Net Price \$23.84

MODEL 1232-A

New AC operated Signal Generator with Triple Shielding and completely NEW design. Top panel is insulated from R.F. Main wiring is beneath double shielded panel. Coils and the band switch are individually shielded. Improved attenuation. Large dial opening improves readability. Dial is direct geared, permitting quick and accurate settings. Six bands cover frequencies from 115 Kc to 30.5 Mc. Total scale length over 50 inches. Direct reading . . .



Dealer Net Price . . \$29.84

ALL THESE MODELS IN PRODUCTION

WRITE FOR CATALOG

SECTION 1611, HARMON AVE.

THE TRIPLET ELECTRICAL INSTRUMENT COMPANY
 Bluffton, Ohio